

ALVA

FRAÇÃO A

ÁREA ÚTIL

165,98 m²

ÁREA BRUTA

204,65 m²

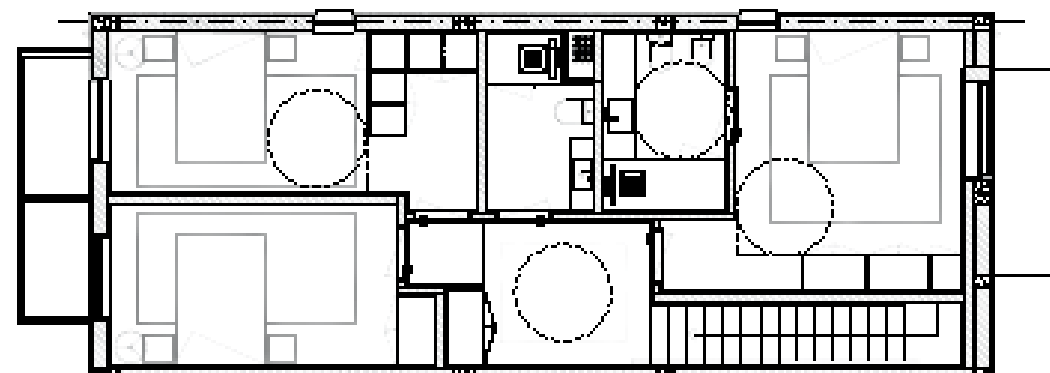

1º Piso

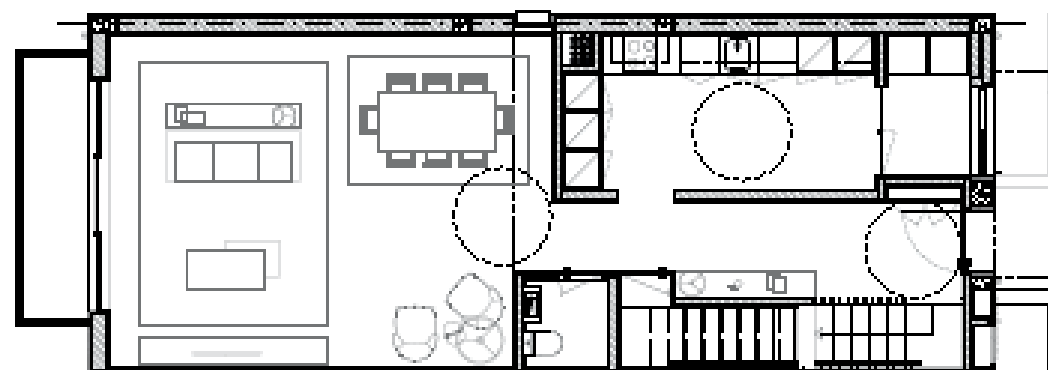

Rés do chão

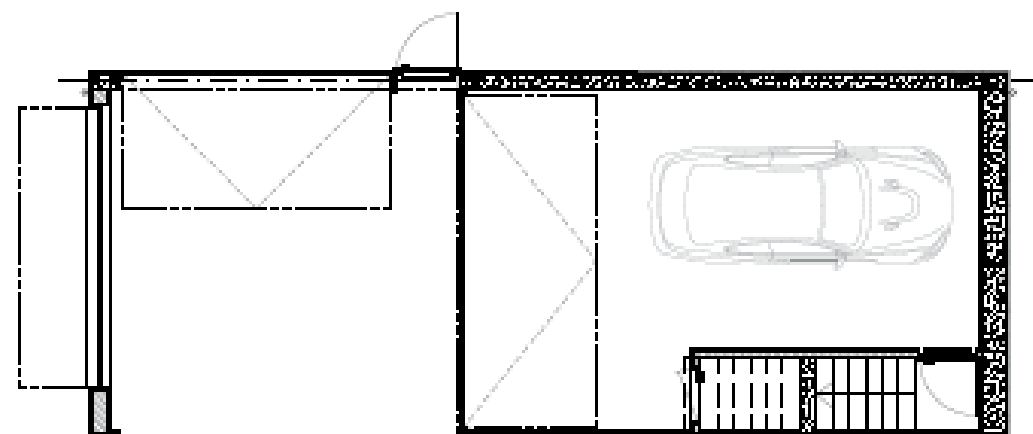

Cave

ALVA

FRAÇÃO B

ÁREA ÚTIL

165,98 m²

ÁREA BRUTA

198,34 m²

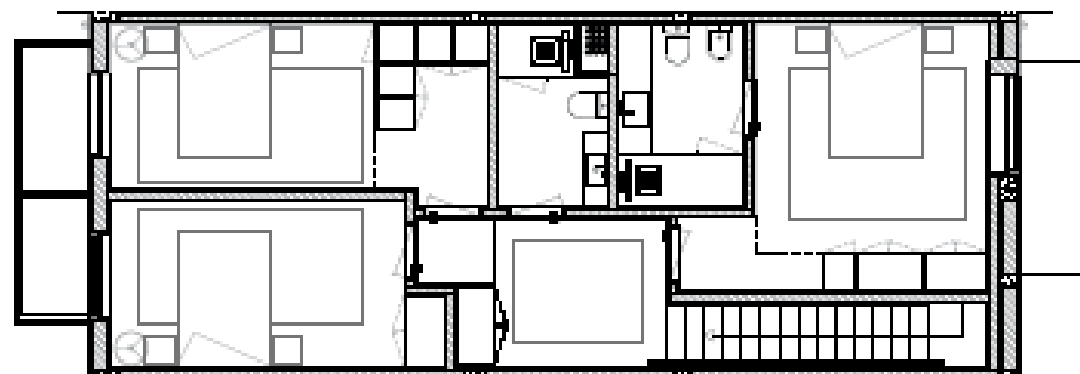

1º Piso

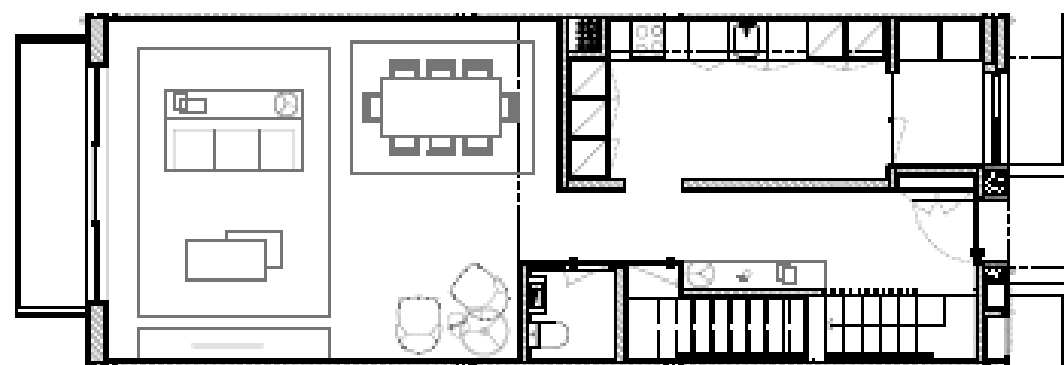

Rés do chão

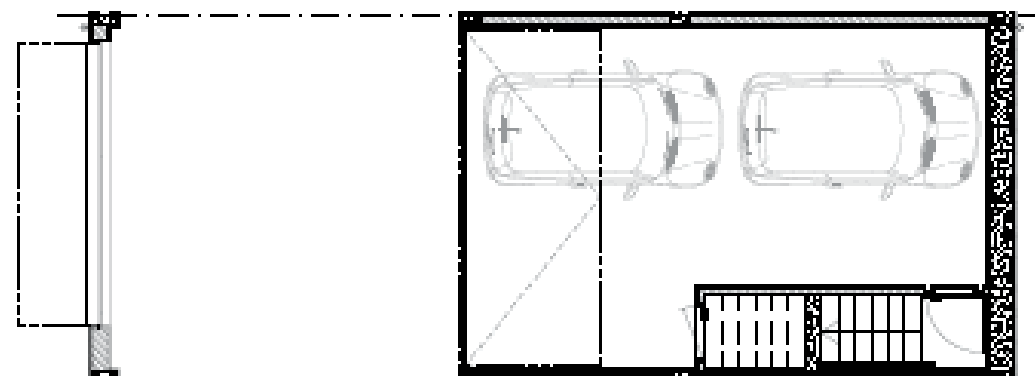

Cave

ALVA

FRAÇÃO C

ÁREA ÚTIL

165,98 m²

ÁREA BRUTA

198,34 m²

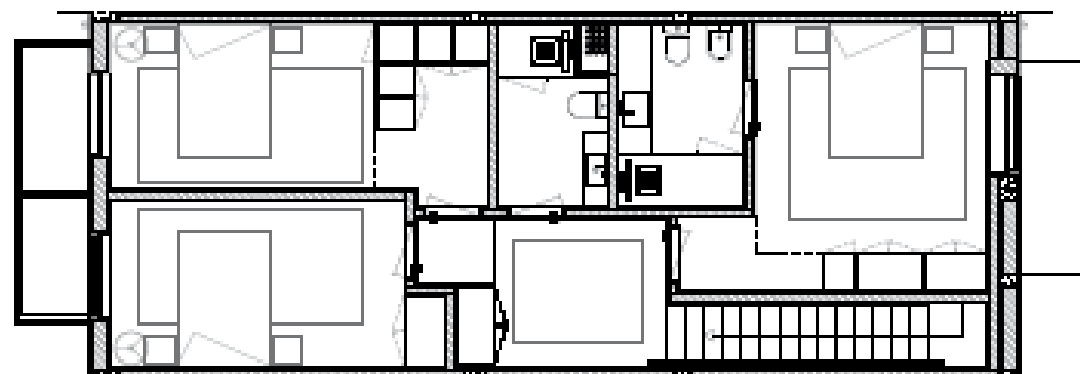

1º Piso

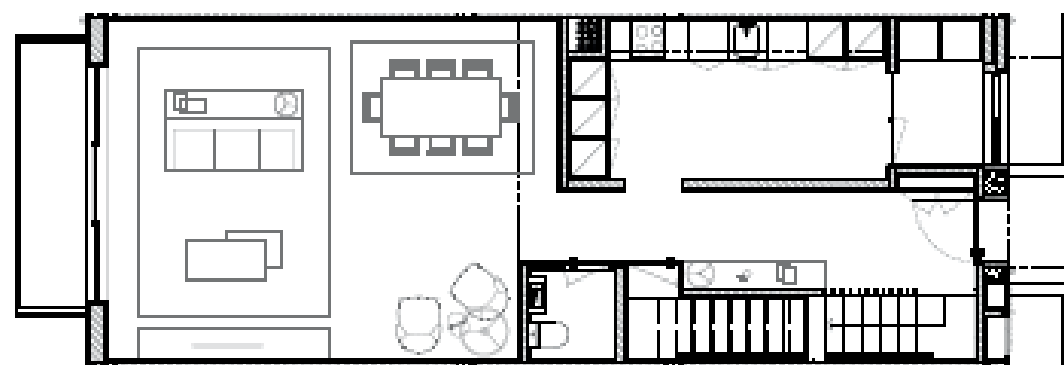

Rés do chão

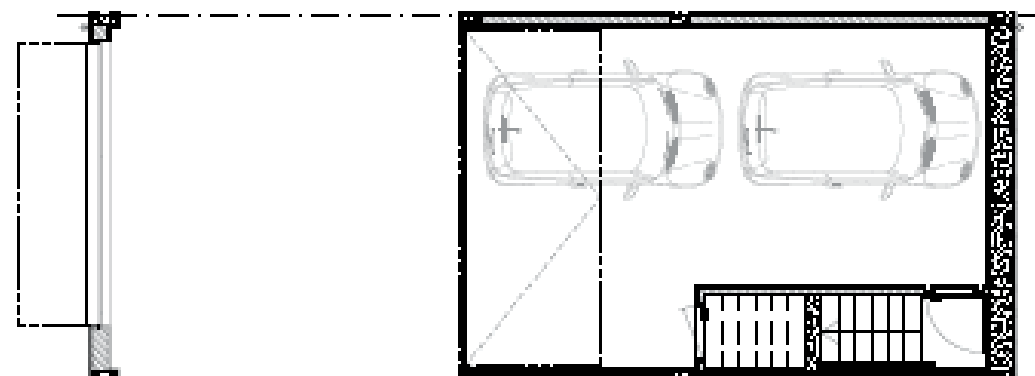

Cave

ALVA

FRAÇÃO D

ÁREA ÚTIL

165,98 m²

ÁREA BRUTA

198,34 m²

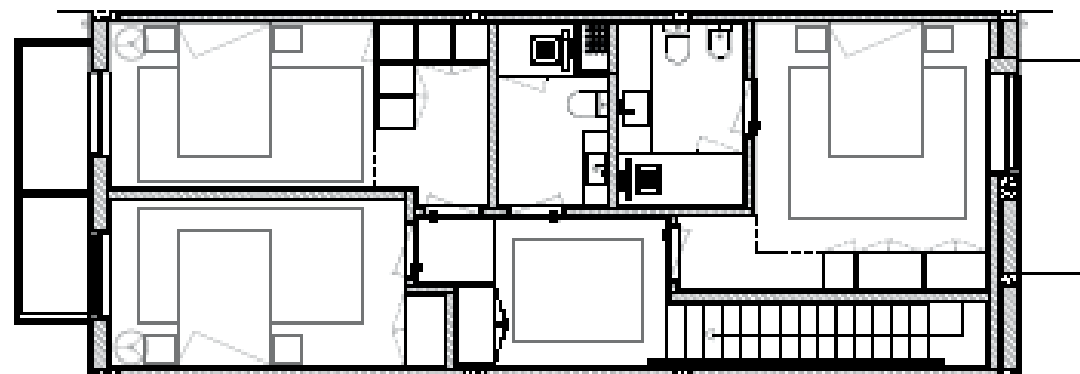

1º Piso

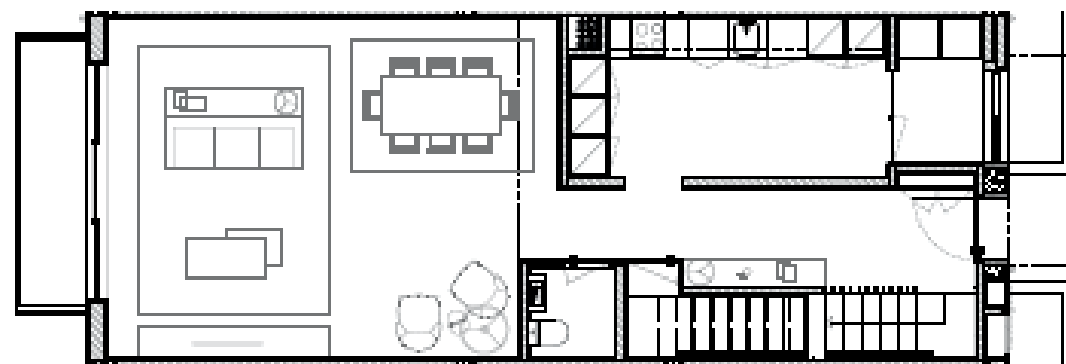

Rés do chão

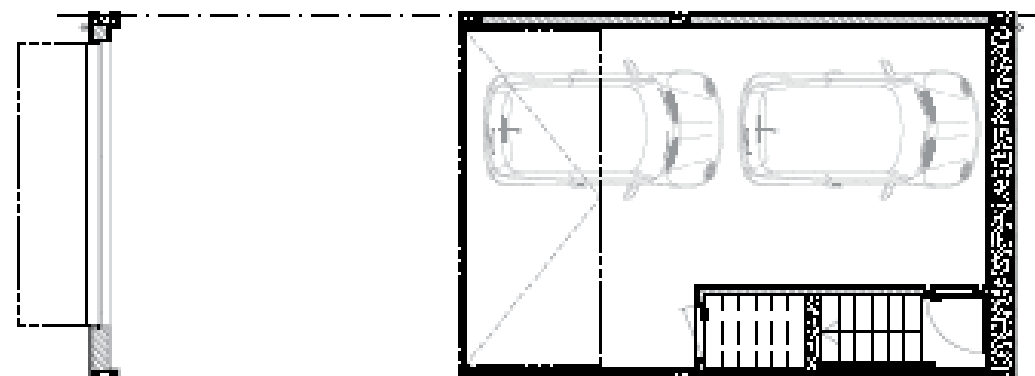

Cave

ALVA

FRAÇÃO E

ÁREA ÚTIL

165,98 m²

ÁREA BRUTA

203,35 m²

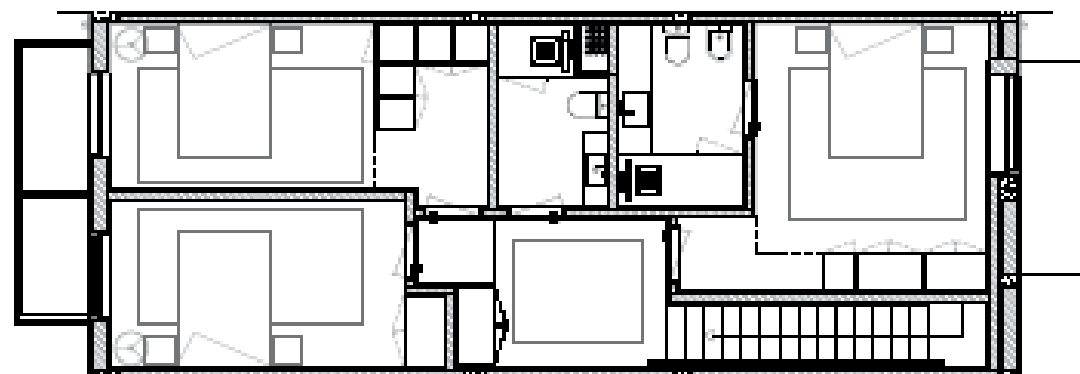

1º Piso

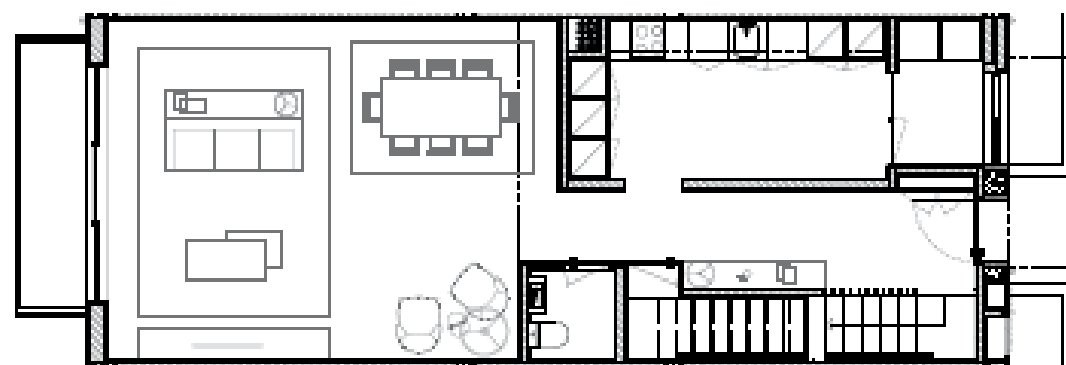

Rés do chão

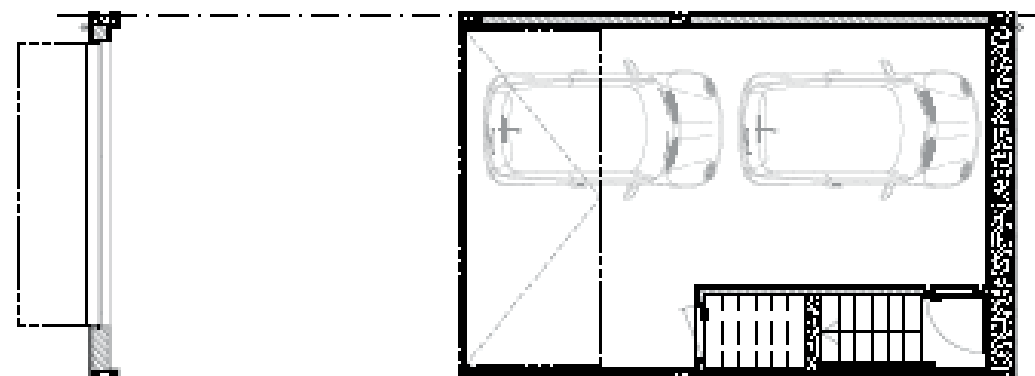

Cave

ALVA

FRAÇÃO F

ÁREA ÚTIL

165,98 m²

ÁREA BRUTA

203,35 m²

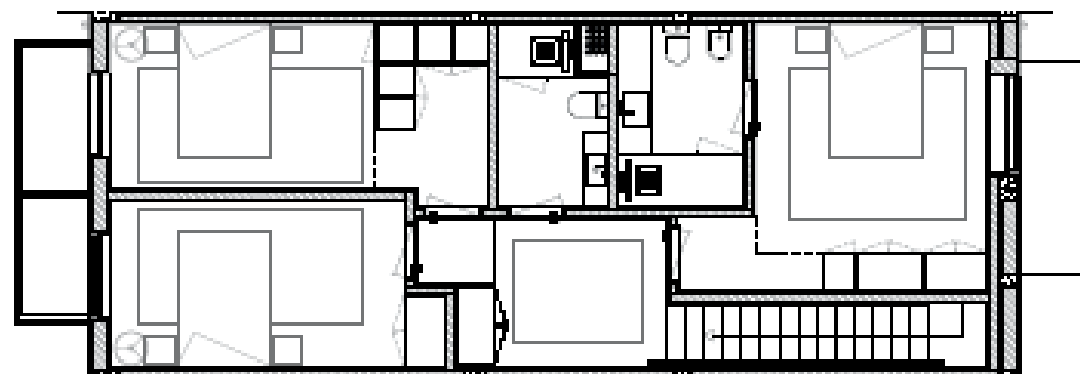

1º Piso

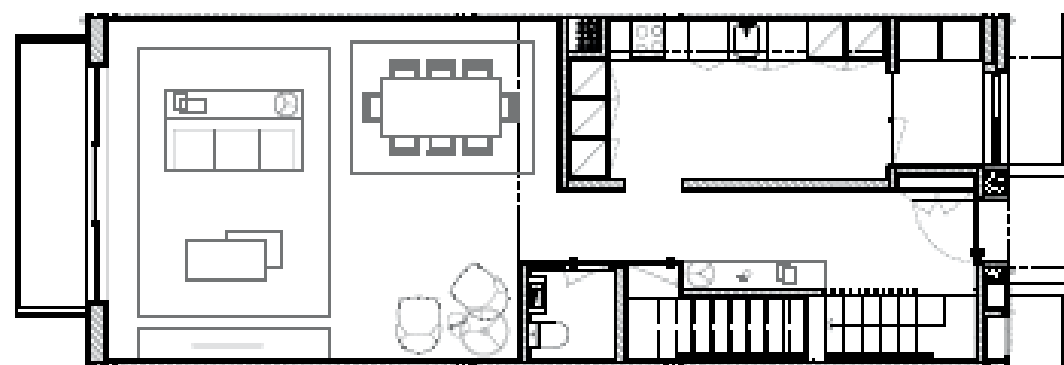

Rés do chão

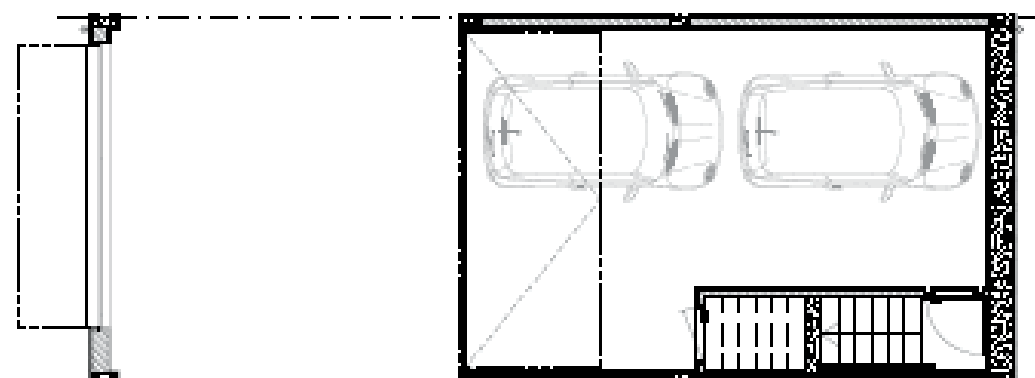

Cave

ALVA

FRAÇÃO G

ÁREA ÚTIL

165,98 m²

ÁREA BRUTA

198,34 m²

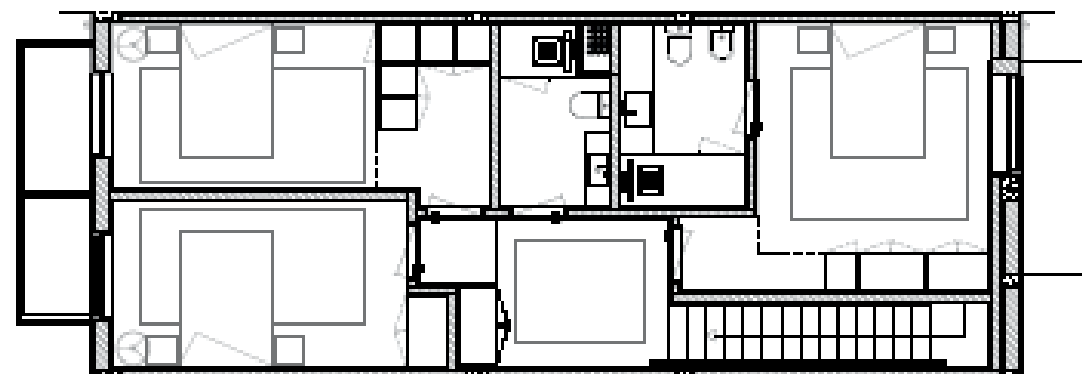

1º Piso

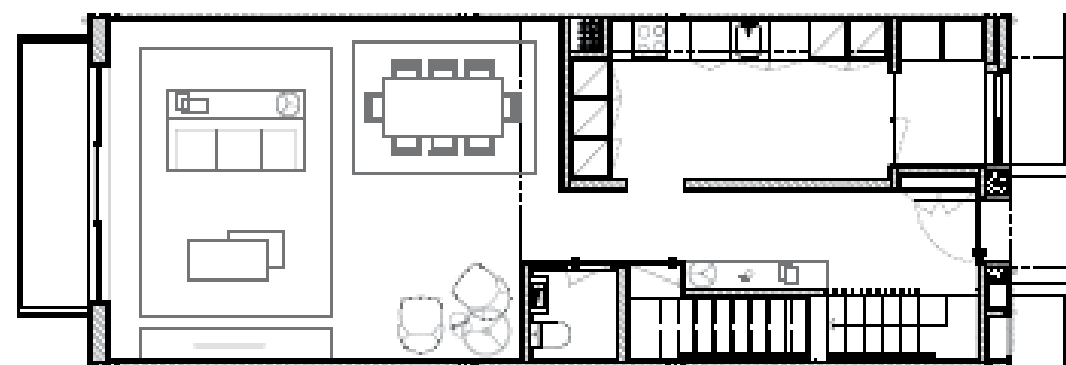

Rés do chão

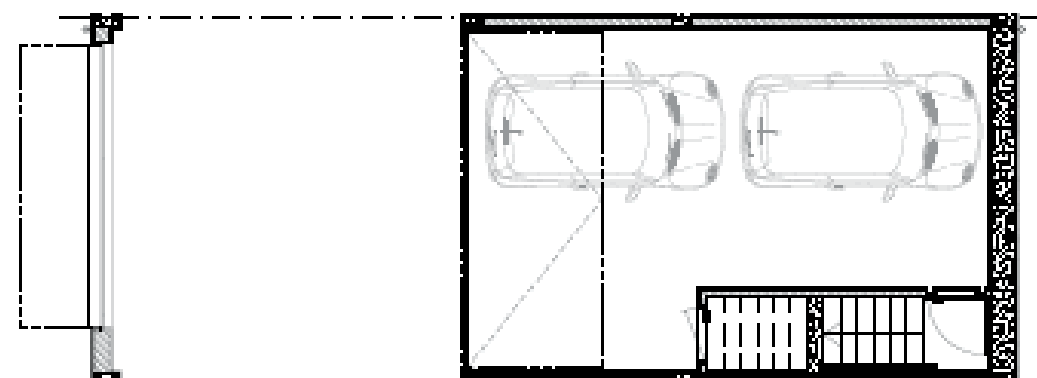

Cave

ALVA

FRAÇÃO H

ÁREA ÚTIL

165,98 m²

ÁREA BRUTA

198,34 m²

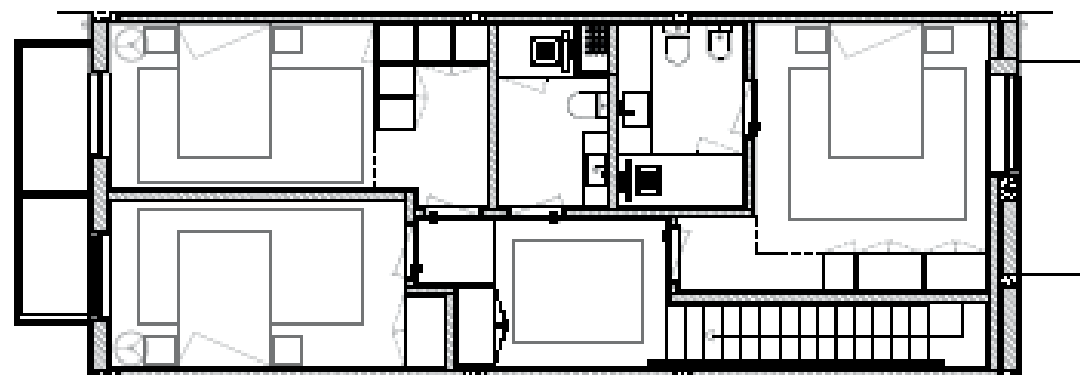

1º Piso

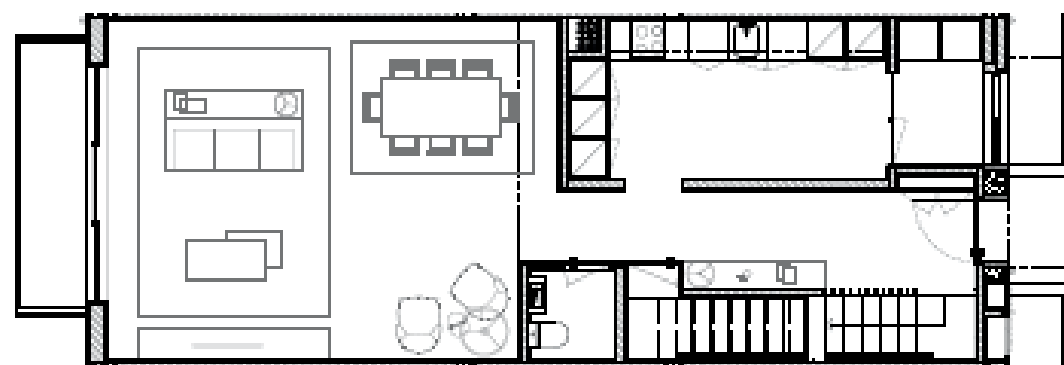

Rés do chão

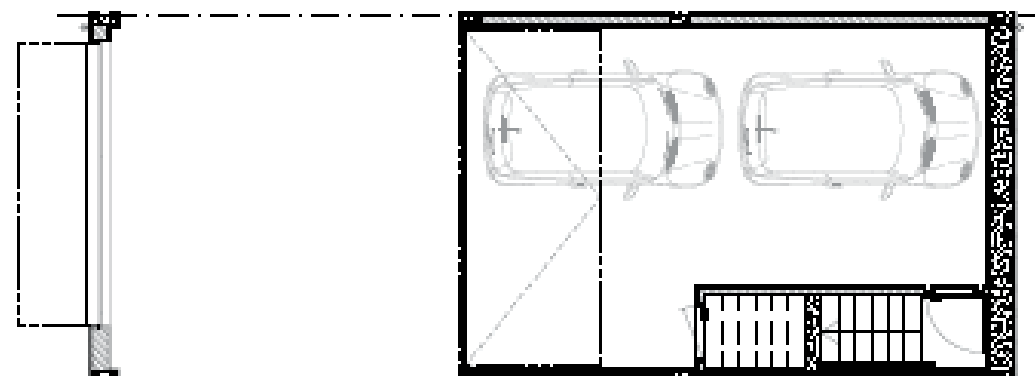

Cave

ALVA

FRAÇÃO I

ÁREA ÚTIL

165,98 m²

ÁREA BRUTA

198,34 m²

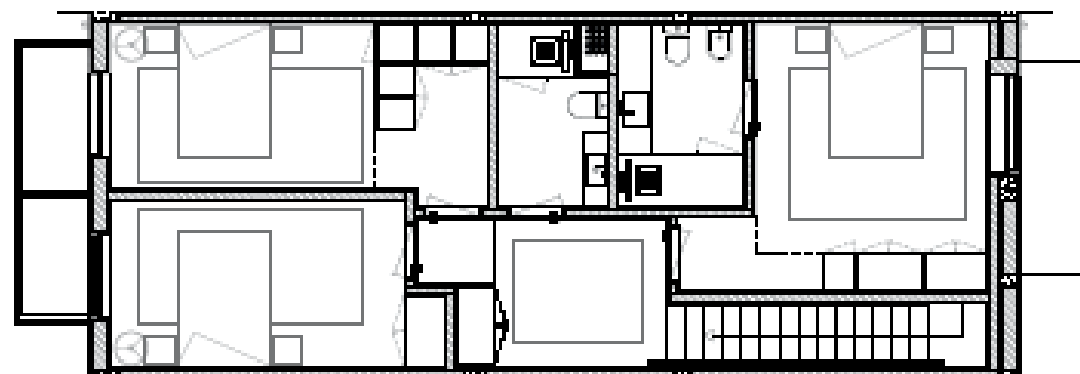

1º Piso

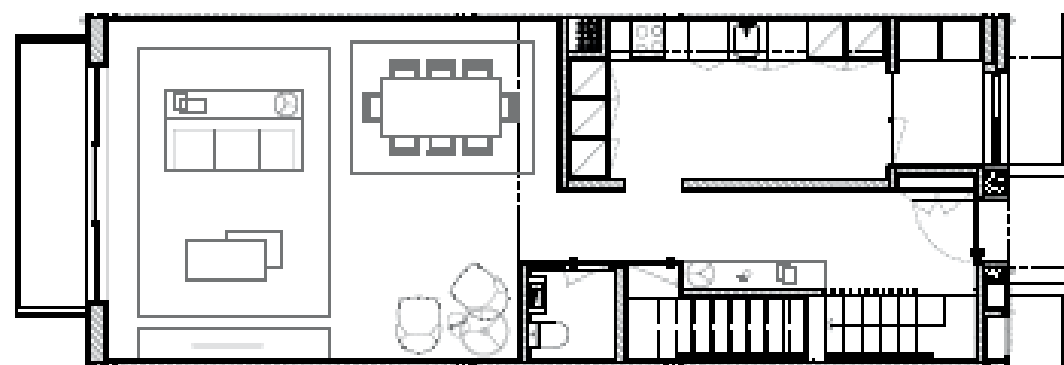

Rés do chão

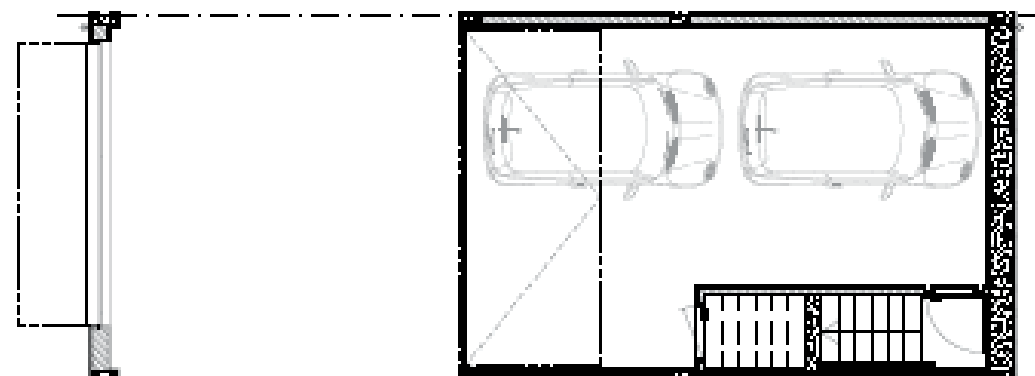

Cave

ALVA

FRAÇÃO J

ÁREA ÚTIL

165,98 m²

ÁREA BRUTA

203,35 m²

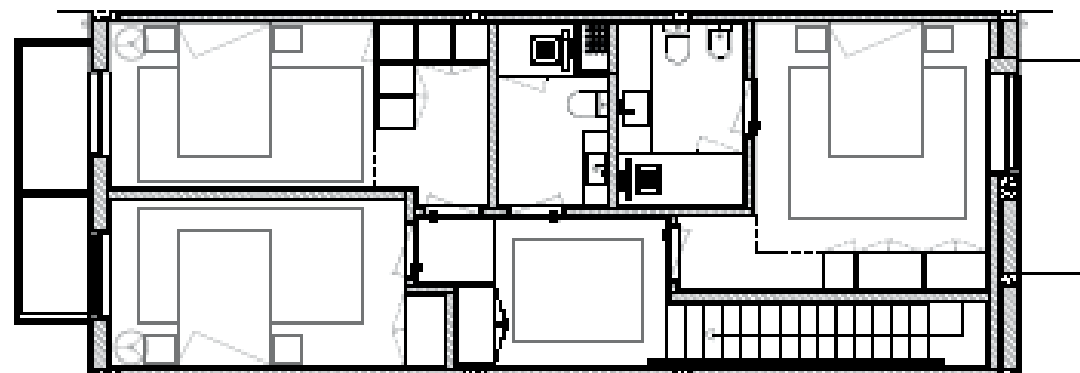

1º Piso

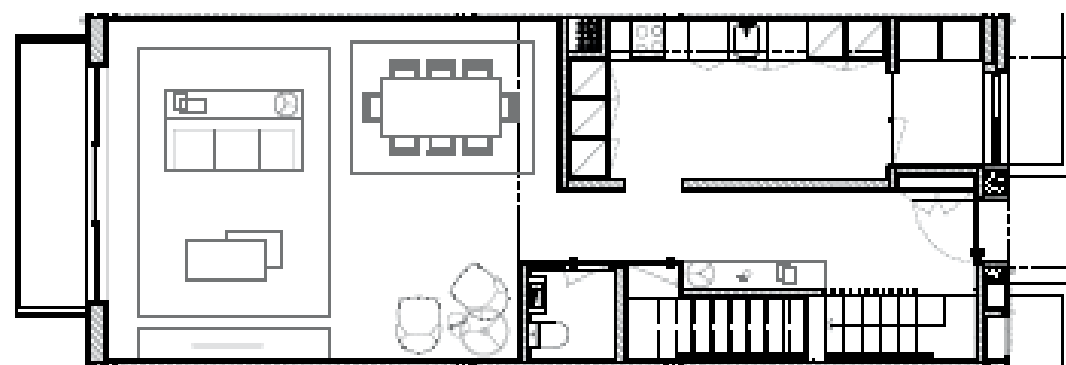

Rés do chão

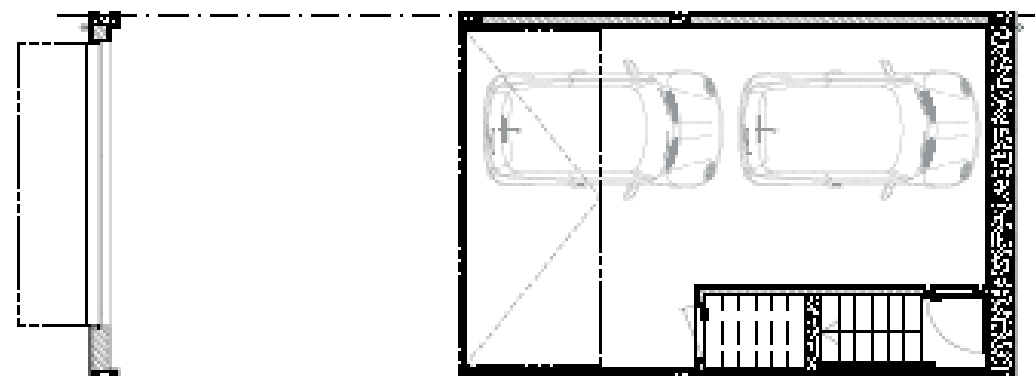

Cave

ALVA

FRAÇÃO K

ÁREA ÚTIL

165,98 m²

ÁREA BRUTA

203,35 m²

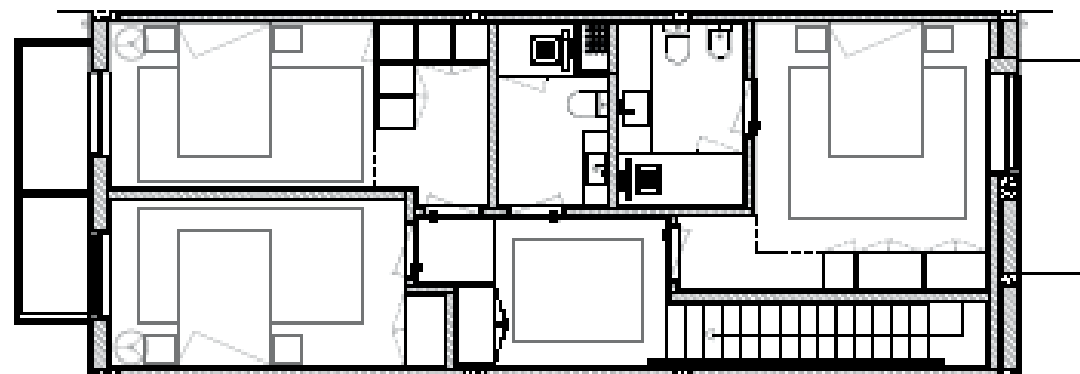

1º Piso

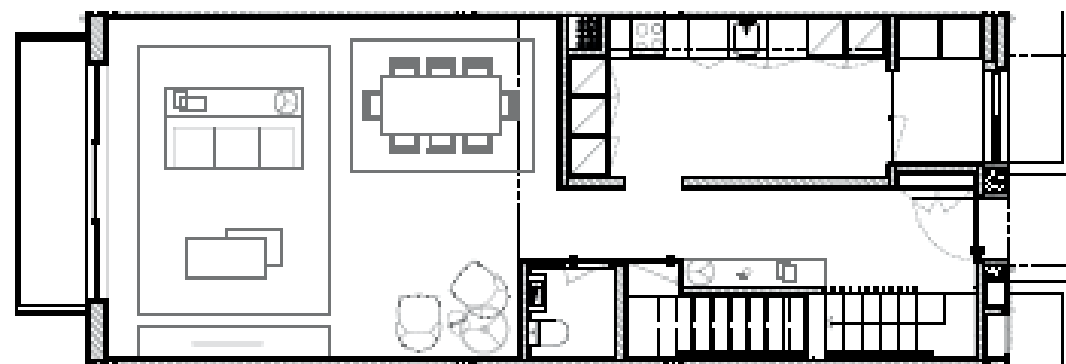

Rés do chão

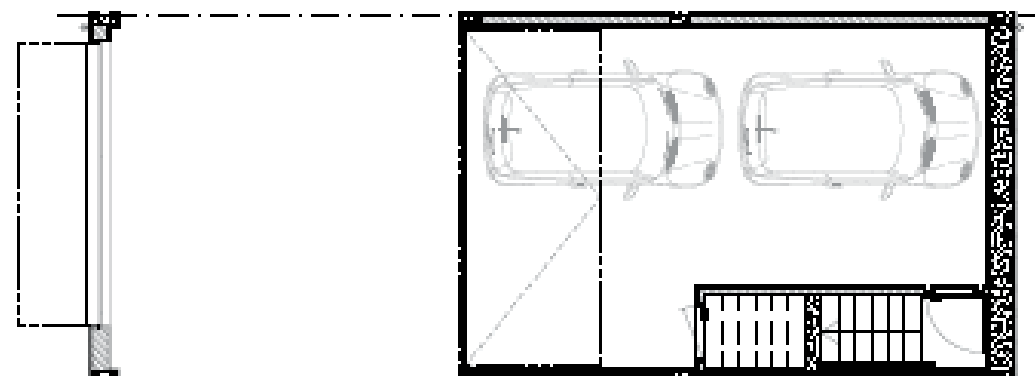

Cave

ALVA

FRAÇÃO L

ÁREA ÚTIL

159,35 m²

ÁREA BRUTA

191,53 m²

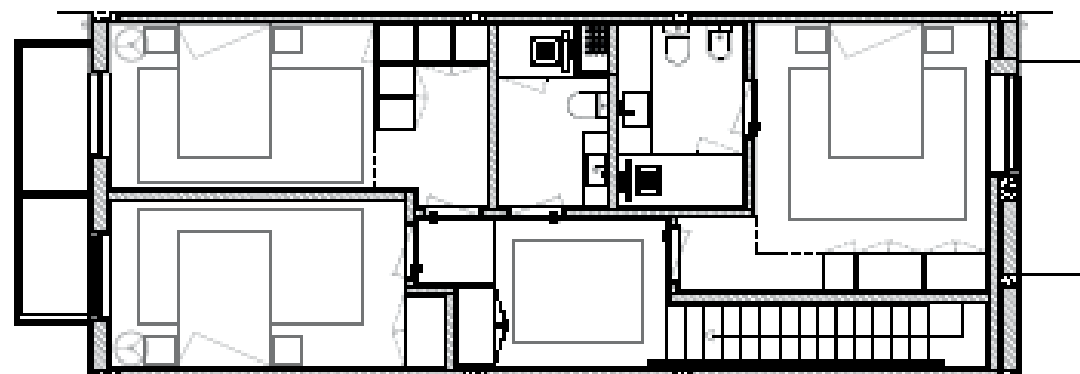

1º Piso

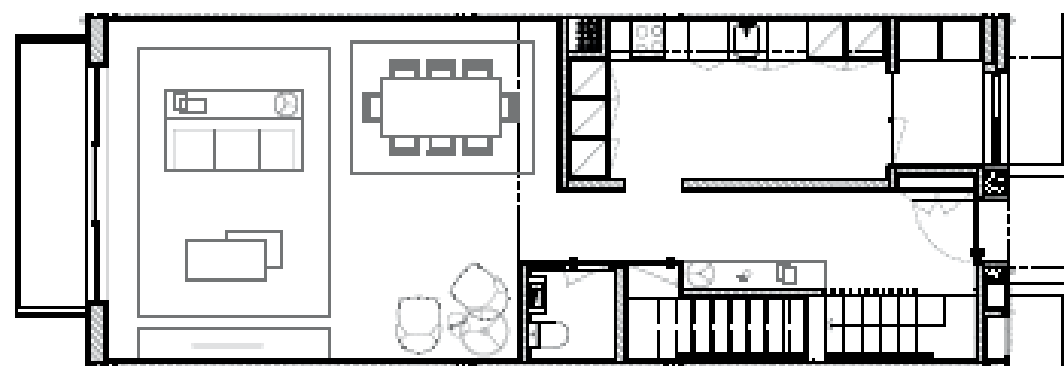

Rés do chão

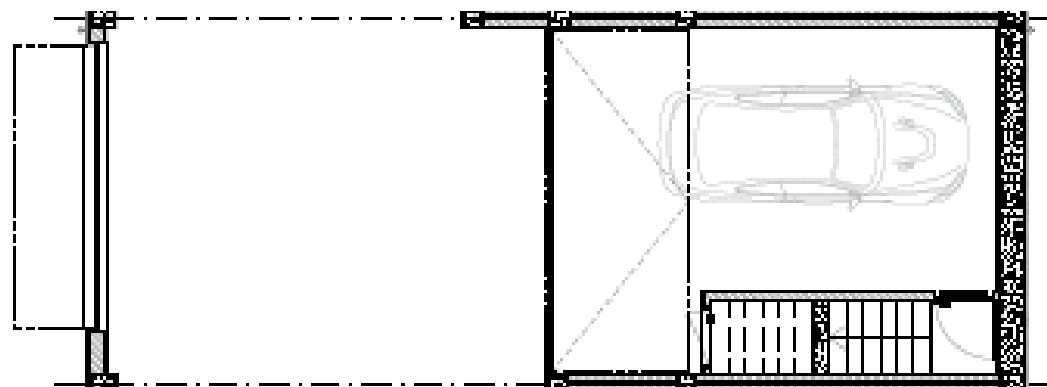

Cave

ALVA

FRAÇÃO M

ÁREA ÚTIL

159,35 m²

ÁREA BRUTA

191,53 m²

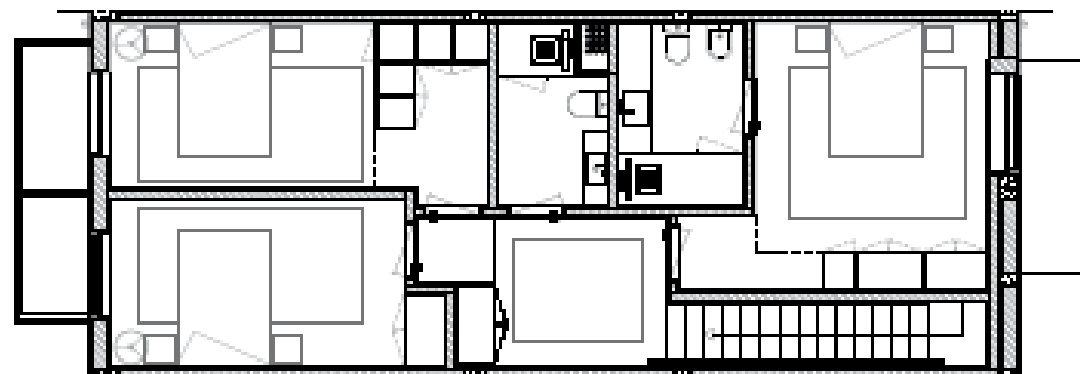

1º Piso

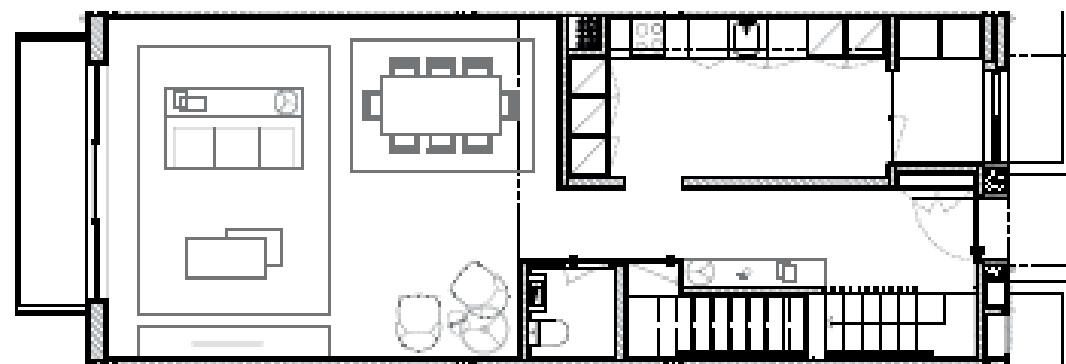

Rés do chão

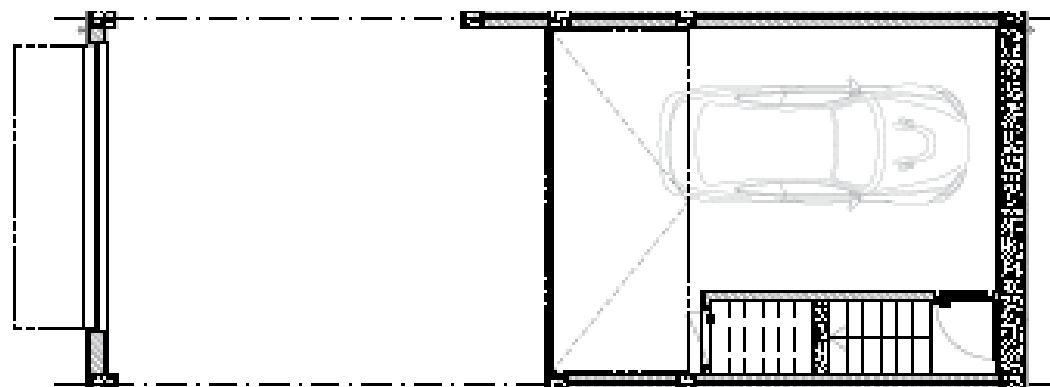

Cave

ALVA

FRAÇÃO N

ÁREA ÚTIL

179,13 m²

ÁREA BRUTA

219,34 m²

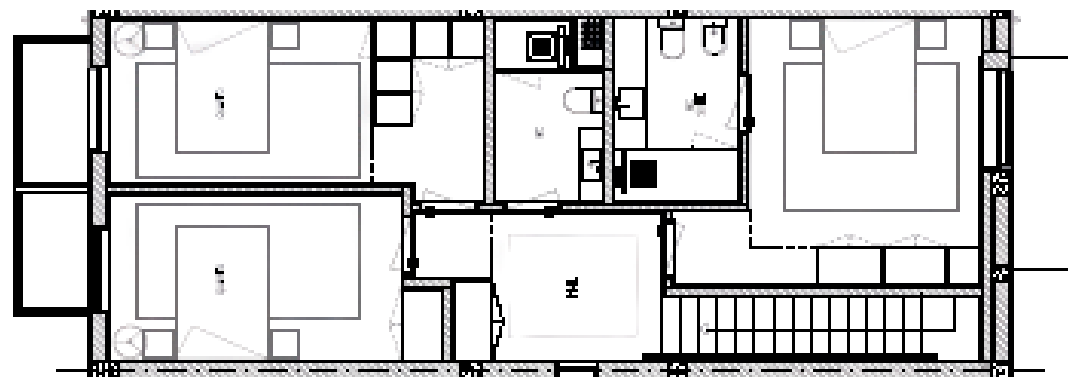

1º Piso

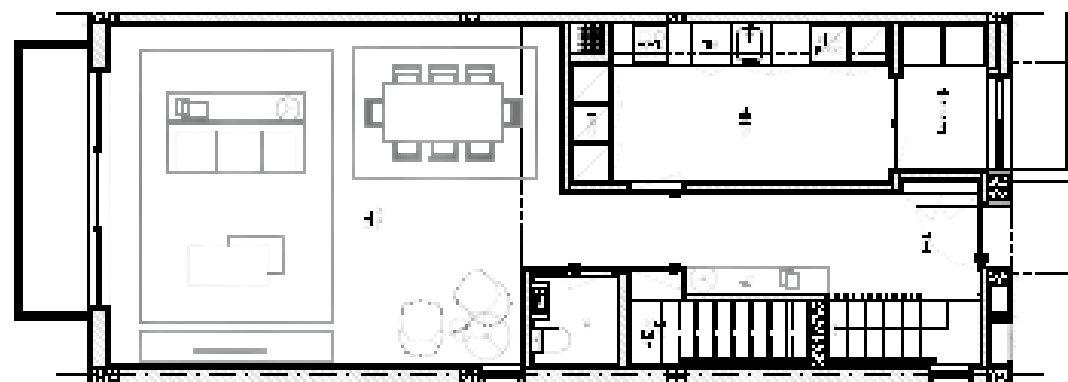

Rés do chão

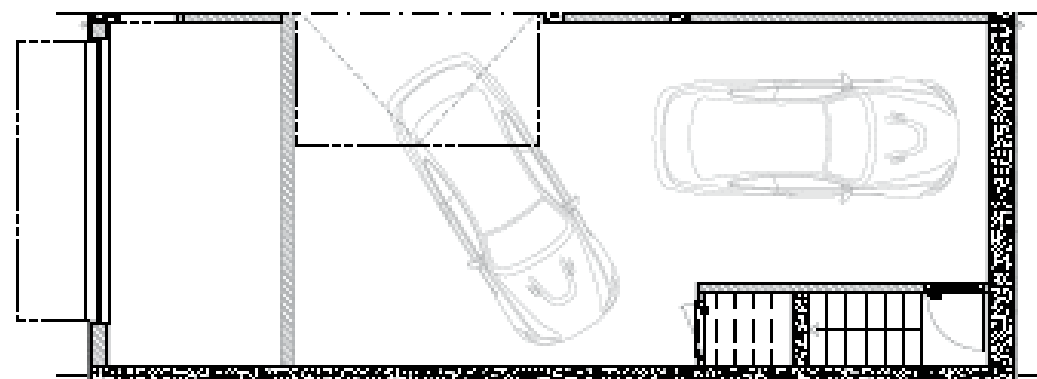

Cave

ALVA

FRAÇÃO 0

ÁREA ÚTIL

193,73 m²

ÁREA BRUTA

236,28 m²

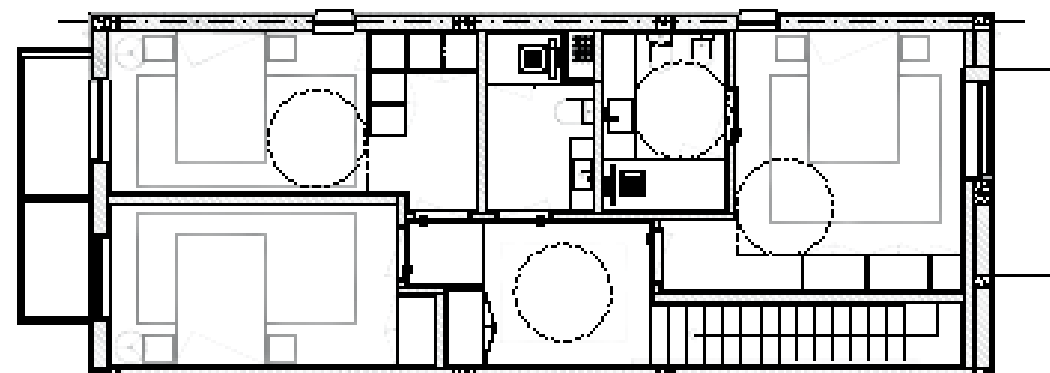

1º Piso

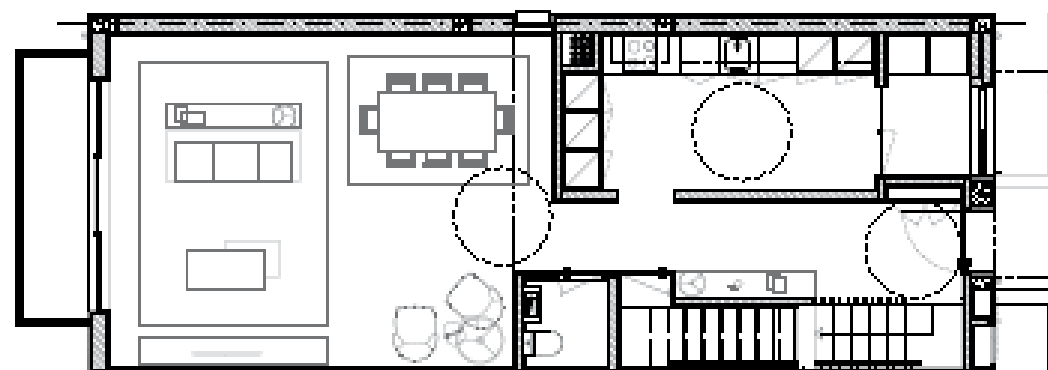

Rés do chão

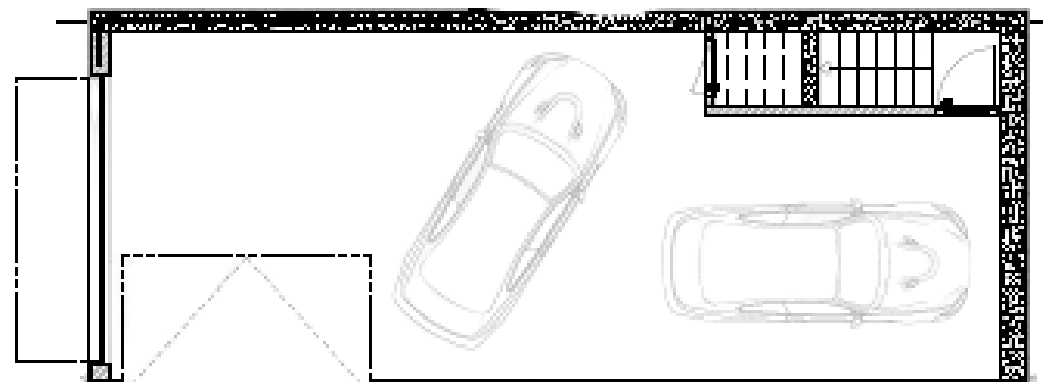

Cave

ALVA

FRAÇÃO P

ÁREA ÚTIL

165,98 m²

ÁREA BRUTA

198,34 m²

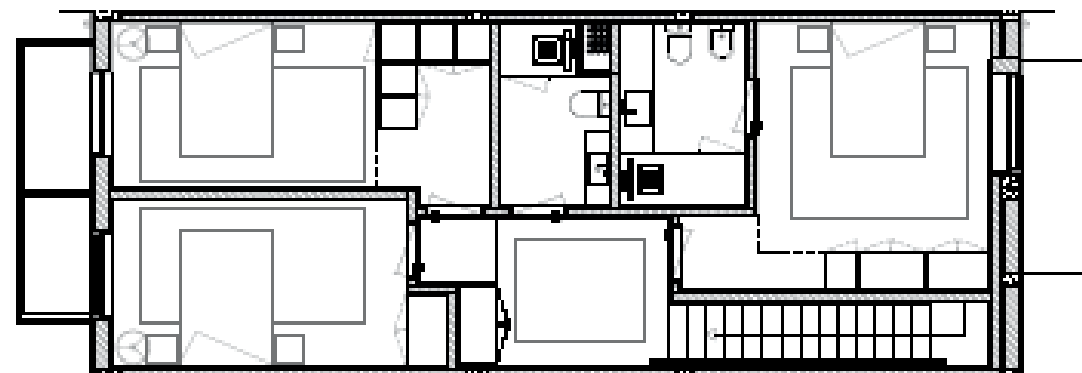

1º Piso

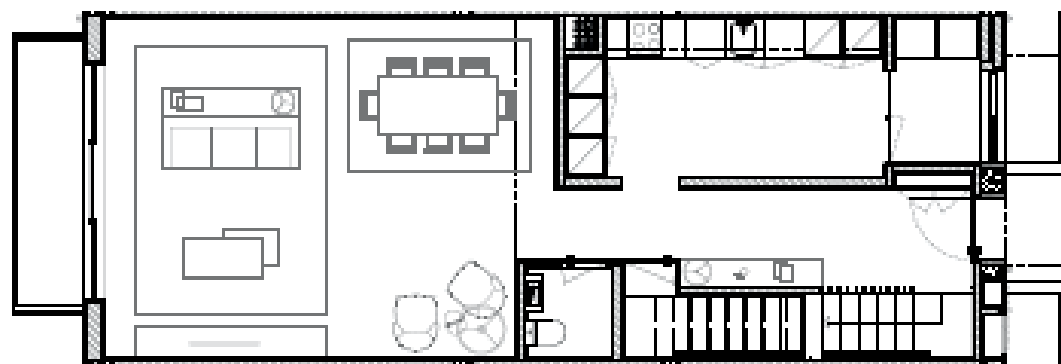

Rés do chão

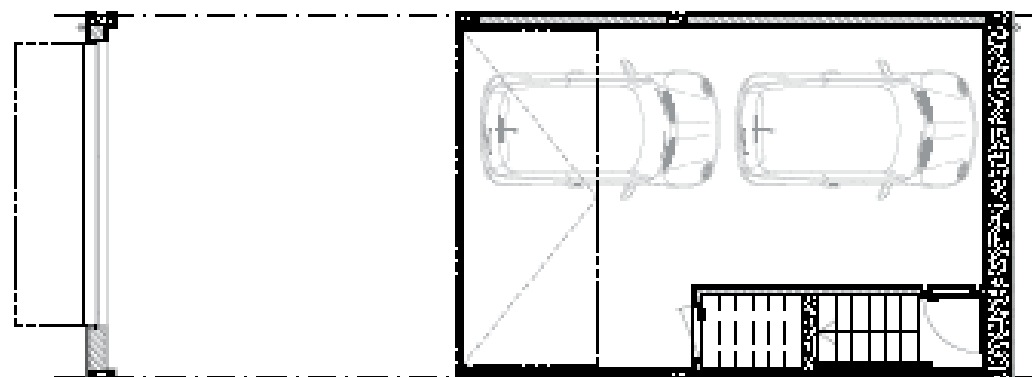

Cave

ALVA

FRAÇÃO Q

ÁREA ÚTIL

165,98 m²

ÁREA BRUTA

198,34 m²

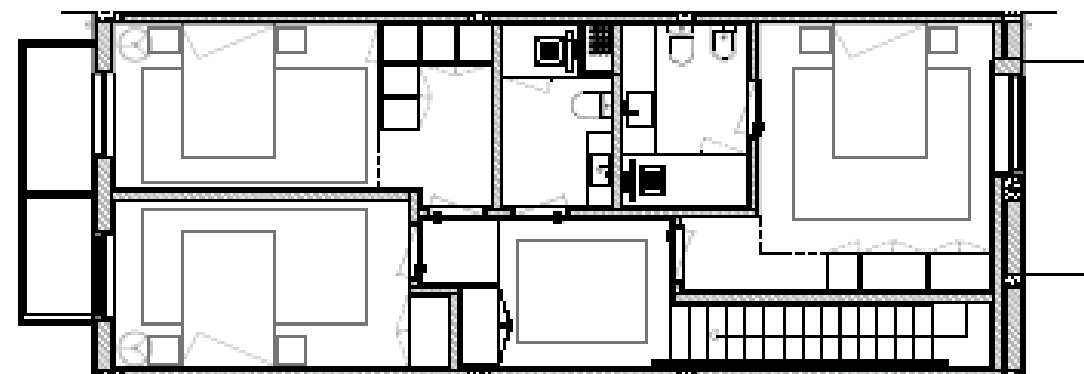

1º Piso

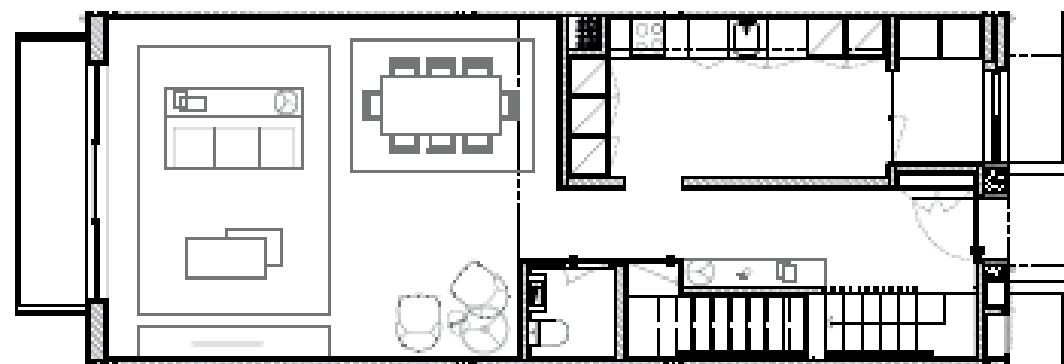

Rés do chão

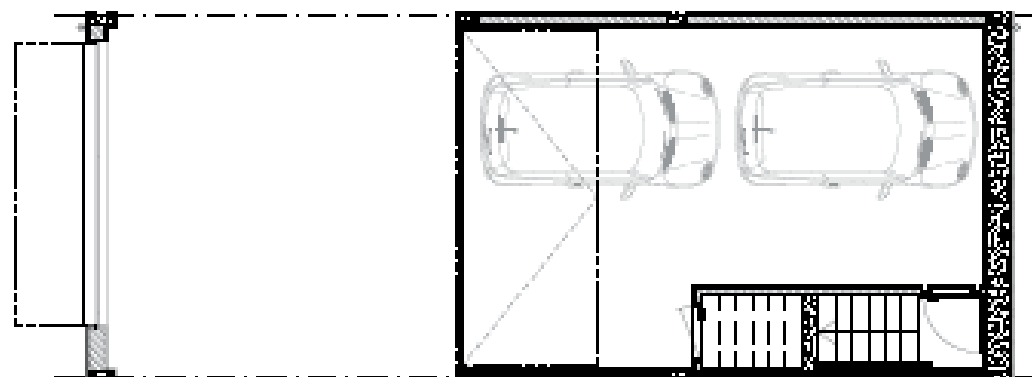

Cave

ALVA

FRAÇÃO R

ÁREA ÚTIL

165,98 m²

ÁREA BRUTA

203,35 m²

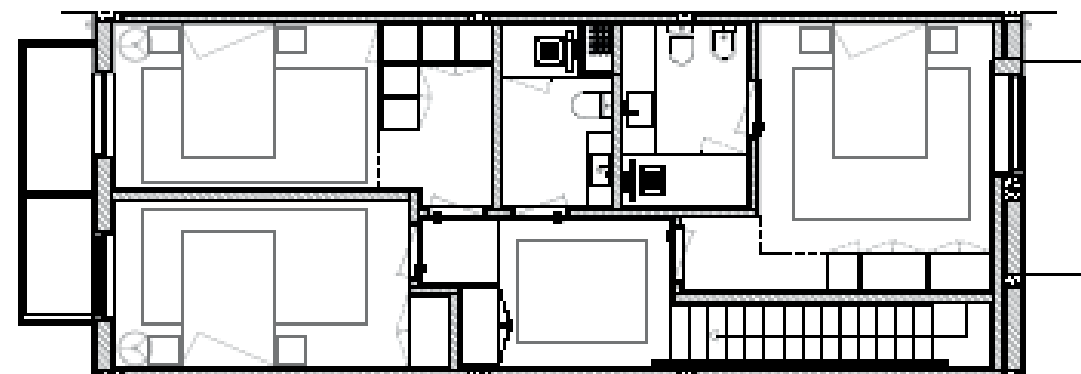

1º Piso

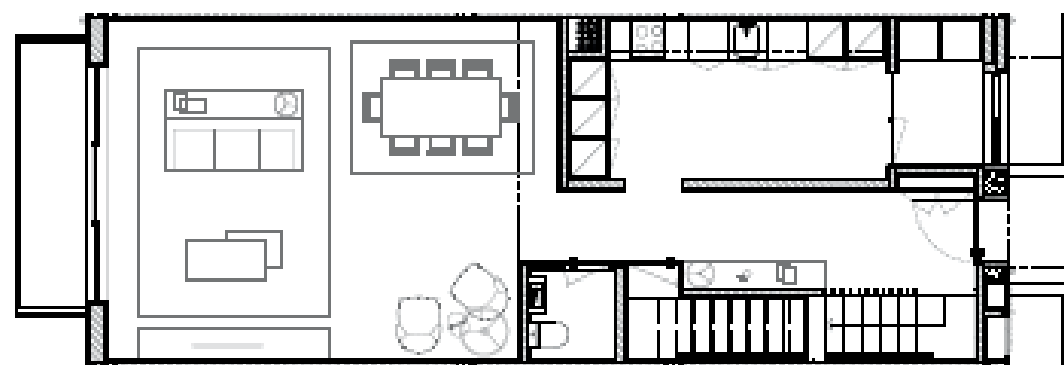

Rés do chão

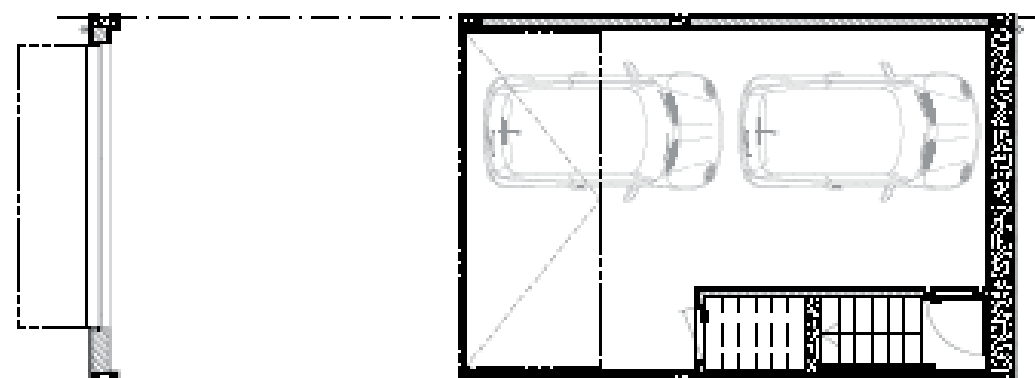

Cave

ALVA

FRAÇÃO S

ÁREA ÚTIL

165,98 m²

ÁREA BRUTA

203,35 m²

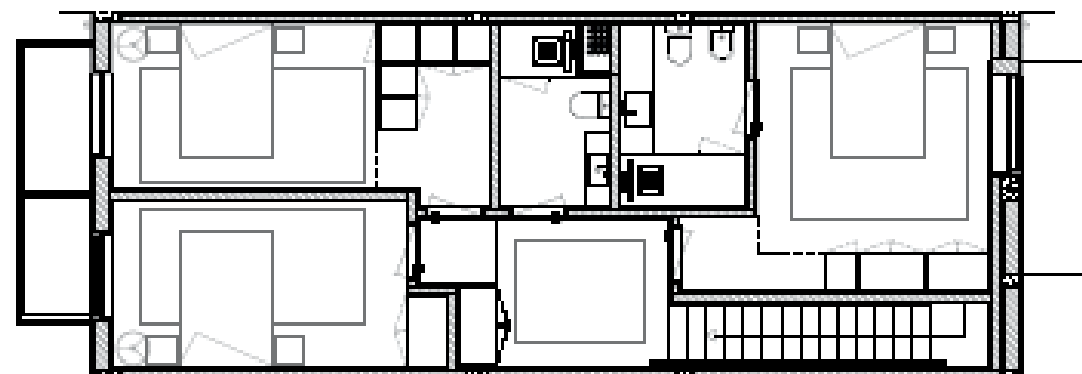

1º Piso

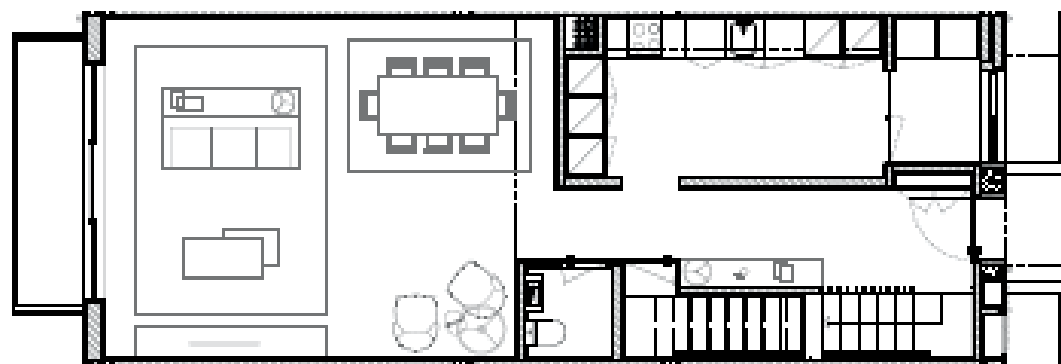

Rés do chão

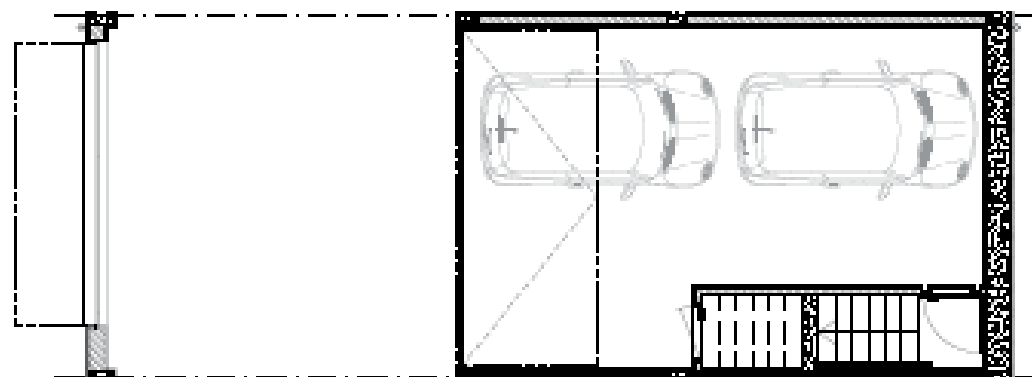

Cave

ALVA

FRAÇÃO T

ÁREA ÚTIL

165,98 m²

ÁREA BRUTA

198,34 m²

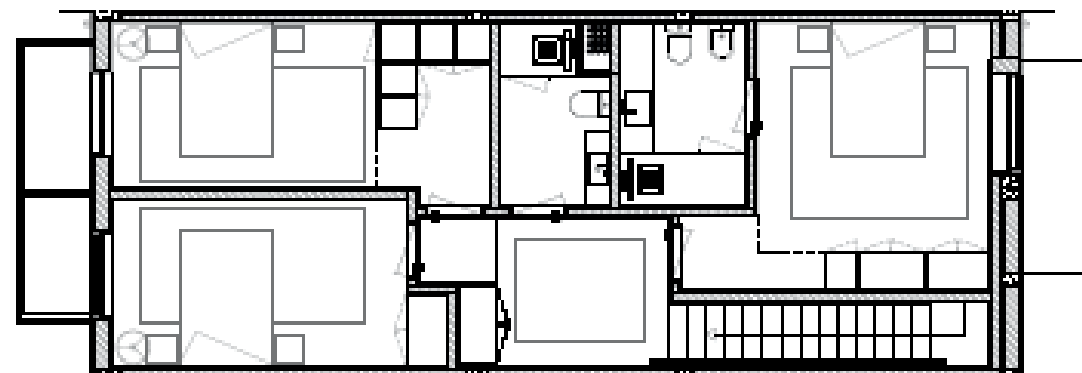

1º Piso

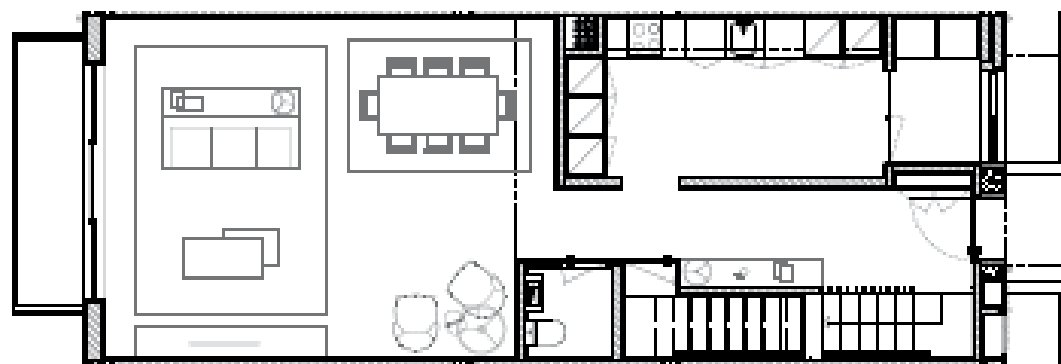

Rés do chão

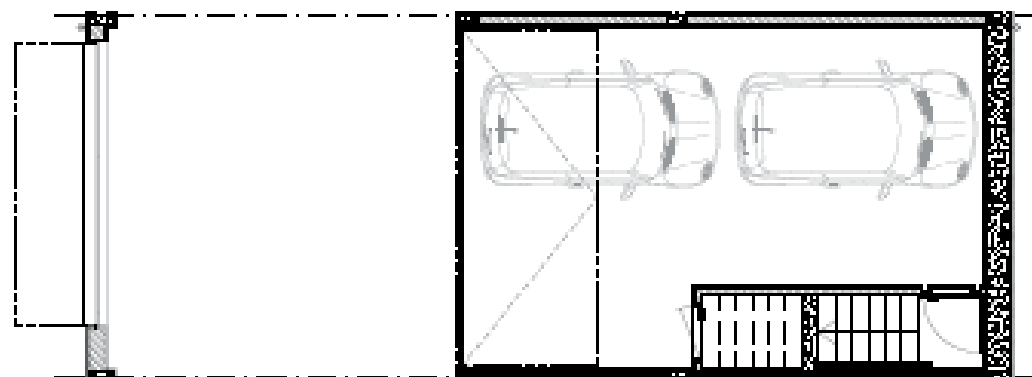

Cave

ALVA

FRAÇÃO U

ÁREA ÚTIL

165,98 m²

ÁREA BRUTA

198,34 m²

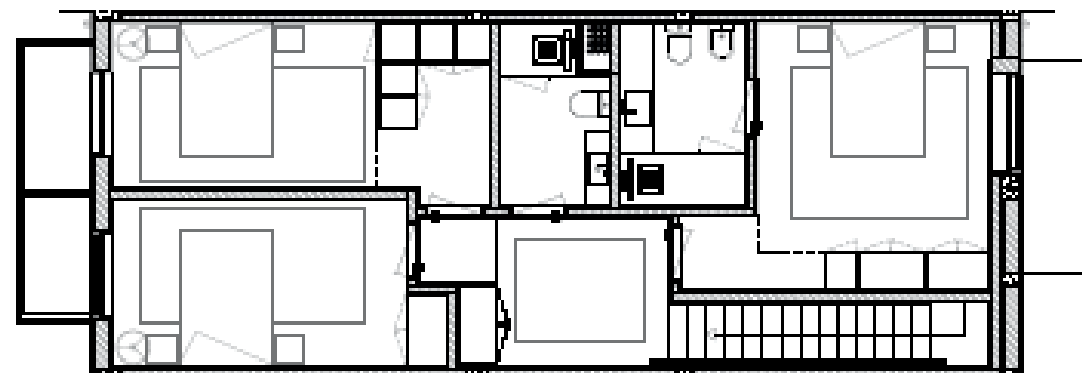

1º Piso

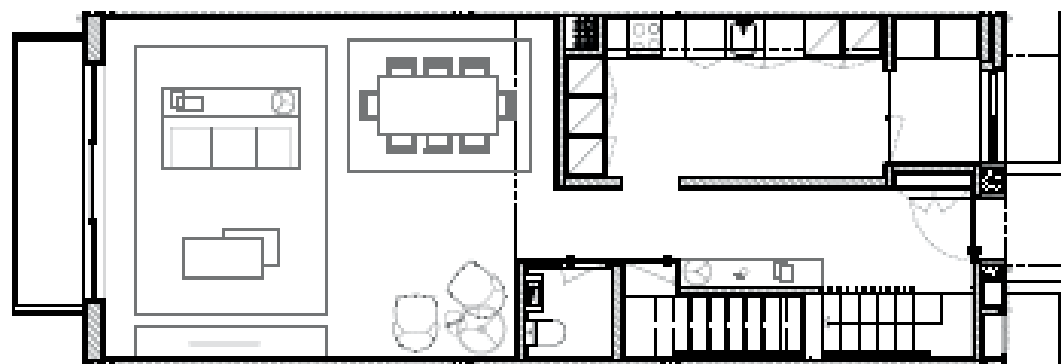

Rés do chão

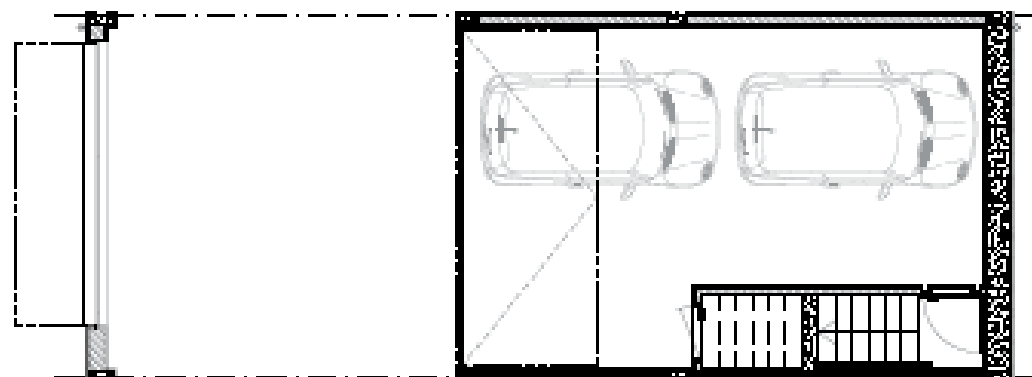

Cave

ALVA

FRAÇÃO V

ÁREA ÚTIL

165,98 m²

ÁREA BRUTA

203,35 m²

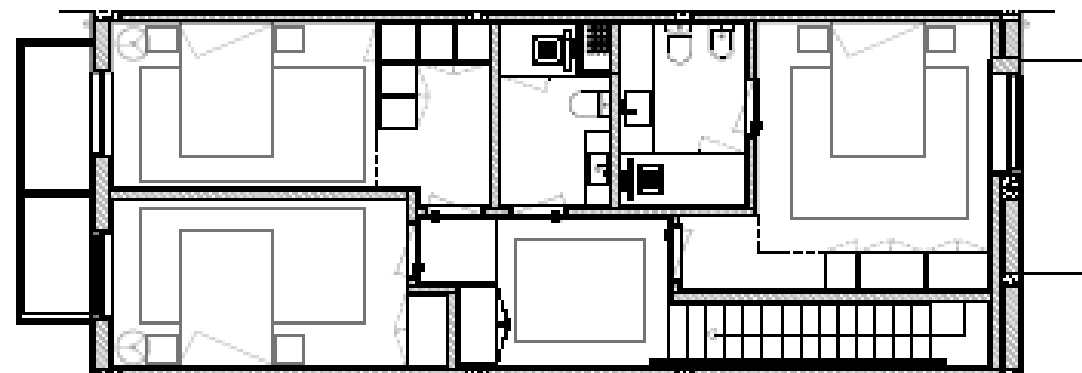

1º Piso

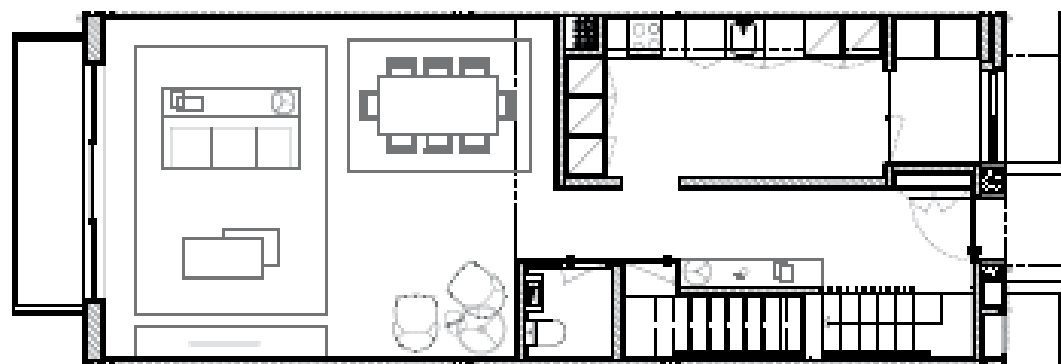

Rés do chão

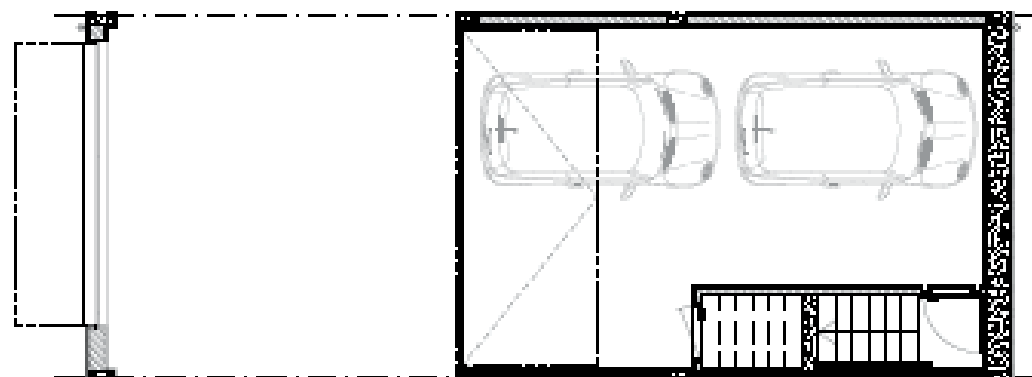

Cave

ALVA

FRAÇÃO W

ÁREA ÚTIL

165,98 m²

ÁREA BRUTA

203,35 m²

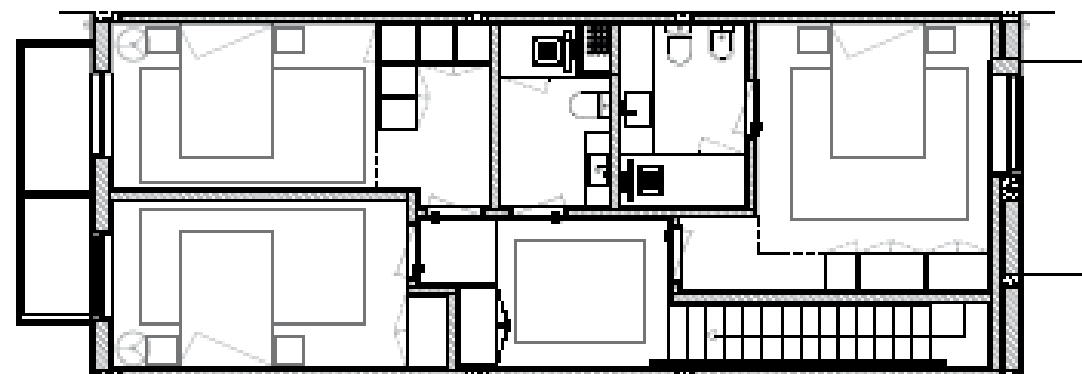

1º Piso

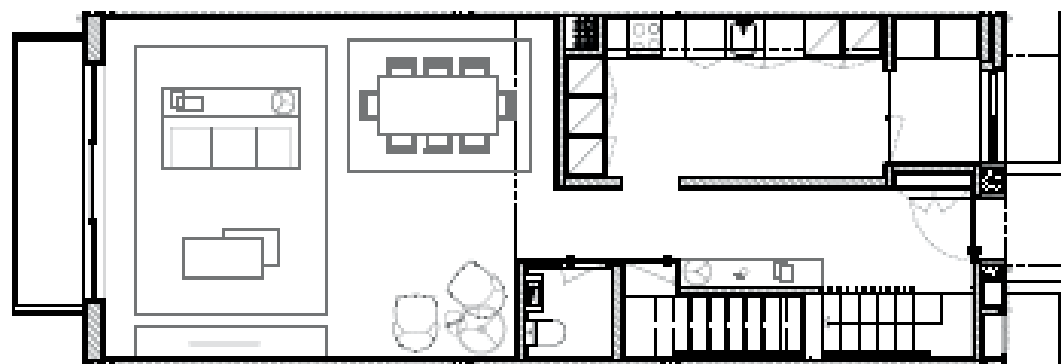

Rés do chão

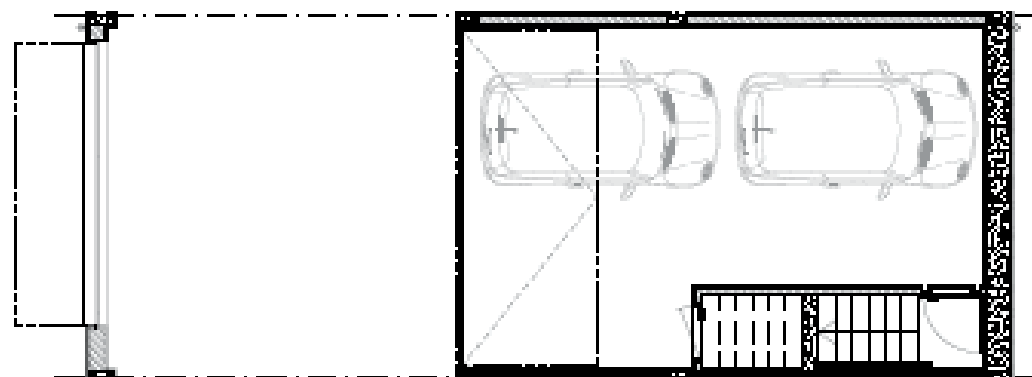

Cave

ALVA

FRAÇÃO X

ÁREA ÚTIL

165,98 m²

ÁREA BRUTA

198,34 m²

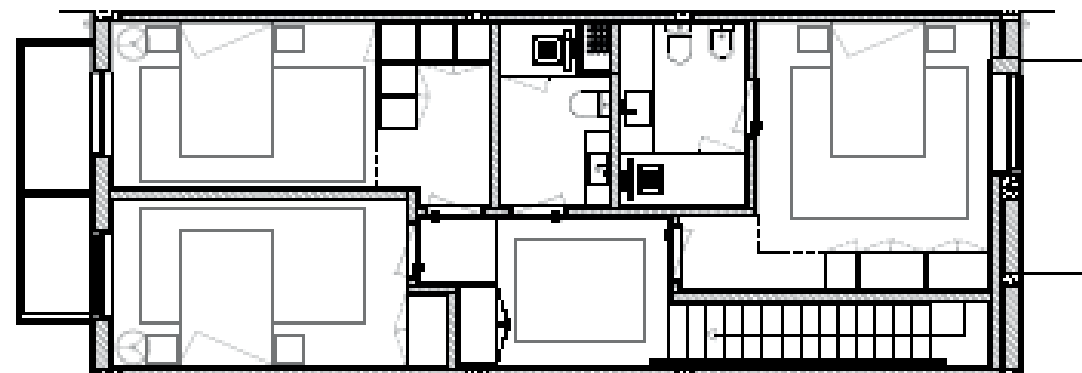

1º Piso

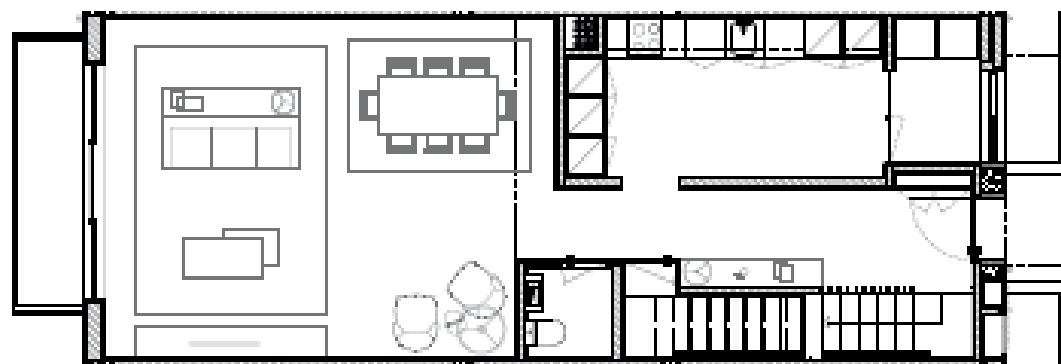

Rés do chão

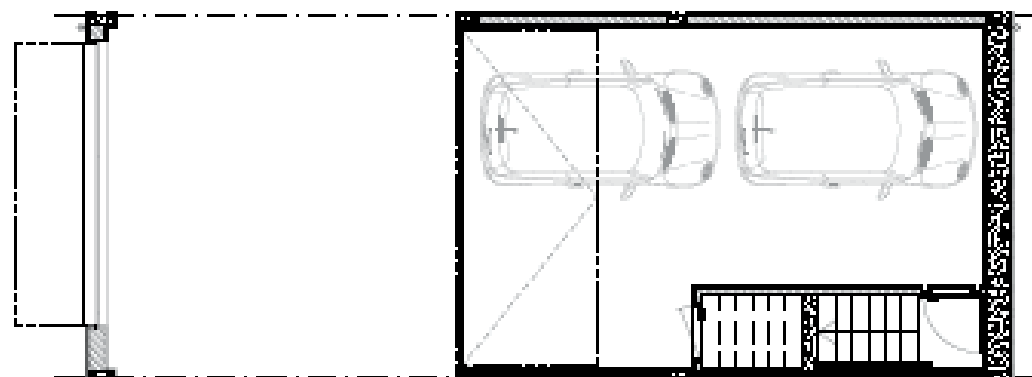

Cave

ALVA

FRAÇÃO Y

ÁREA ÚTIL

165,98 m²

ÁREA BRUTA

198,34 m²

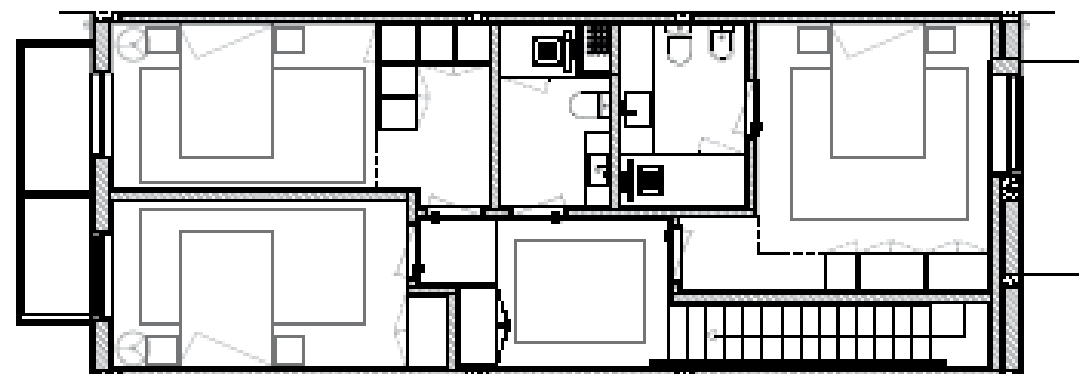

1º Piso

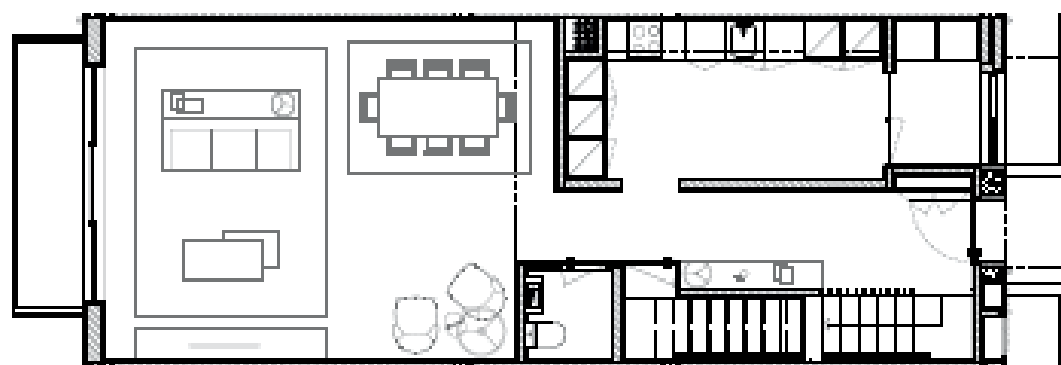

Rés do chão

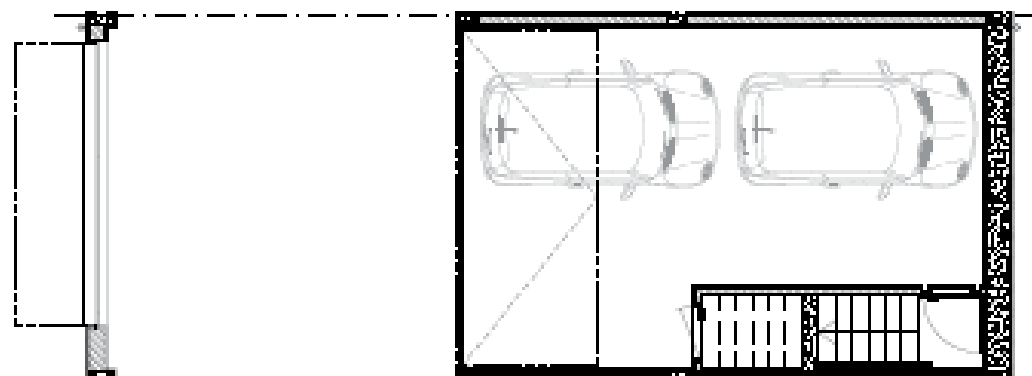

Cave

ALVA

FRAÇÃO Z

ÁREA ÚTIL

165,98 m²

ÁREA BRUTA

203,35 m²

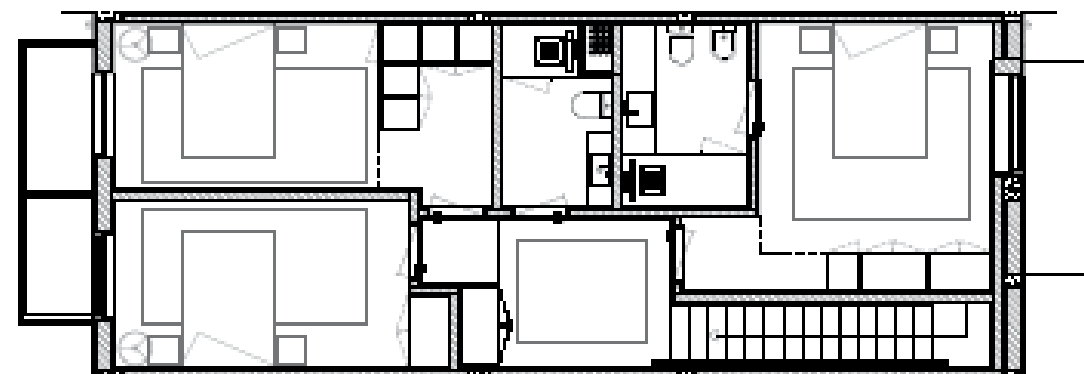

1º Piso

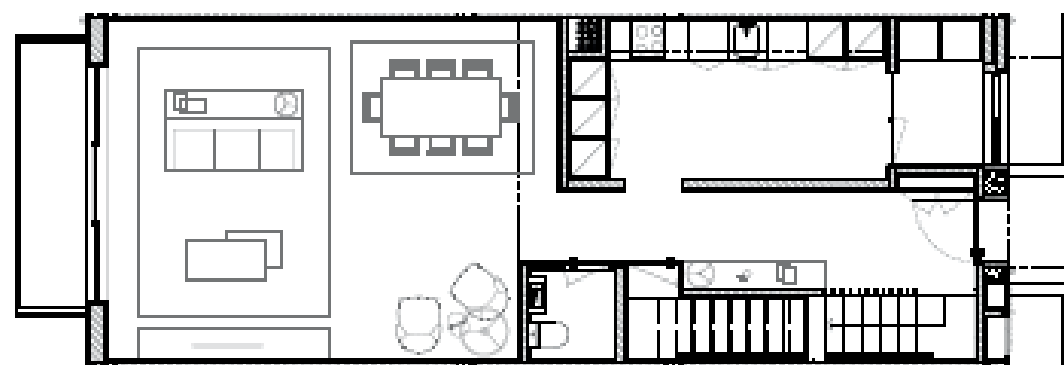

Rés do chão

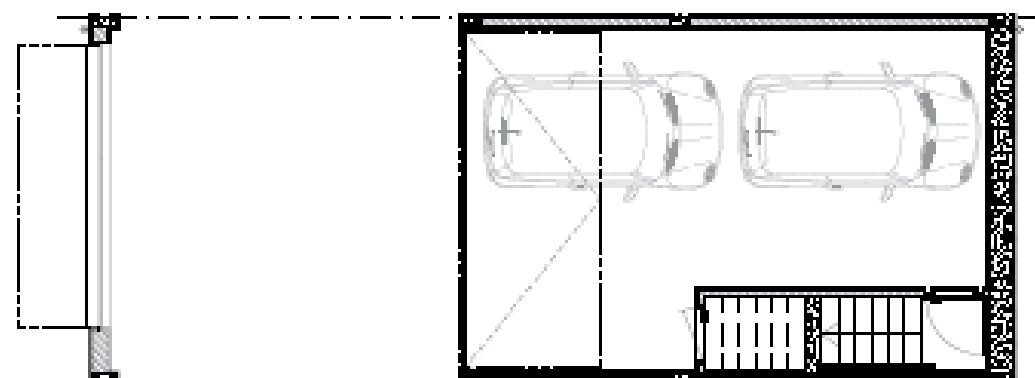

Cave

ALVA

FRAÇÃO AA

ÁREA ÚTIL

165,98 m²

ÁREA BRUTA

203,35 m²

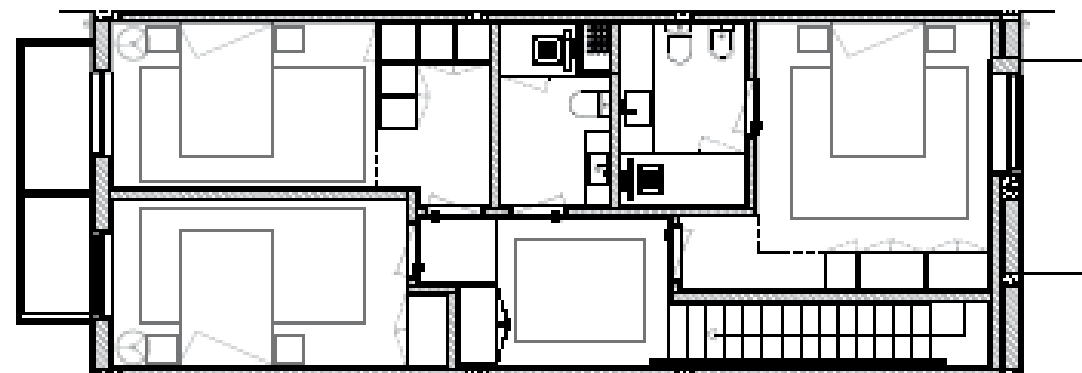

1º Piso

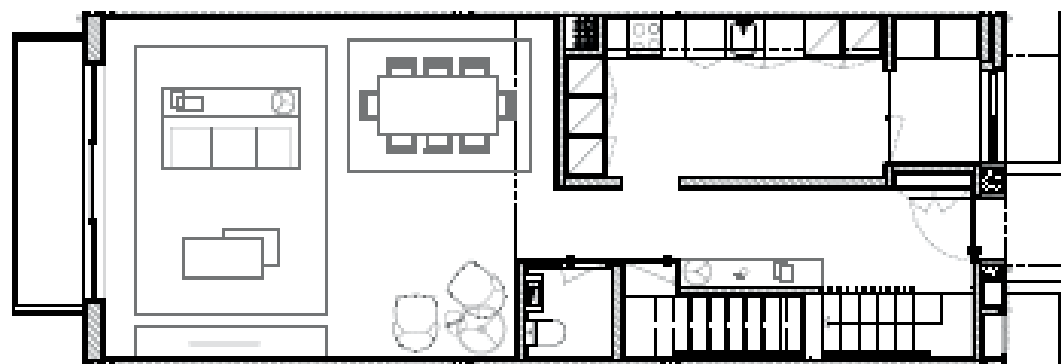

Rés do chão

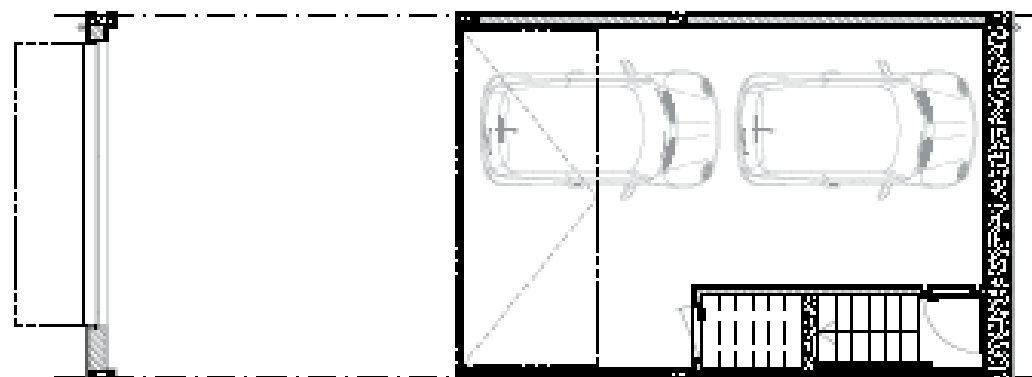

Cave

ALVA

FRAÇÃO AB

ÁREA ÚTIL

159,35 m²

ÁREA BRUTA

191,53 m²

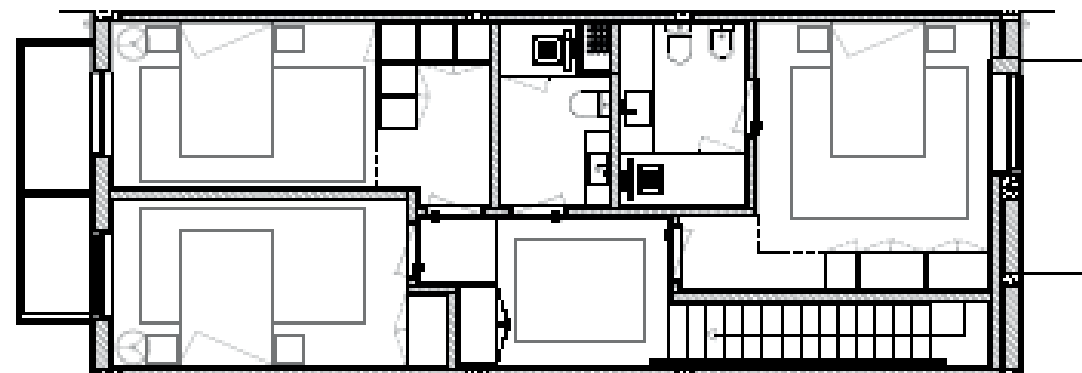

1º Piso

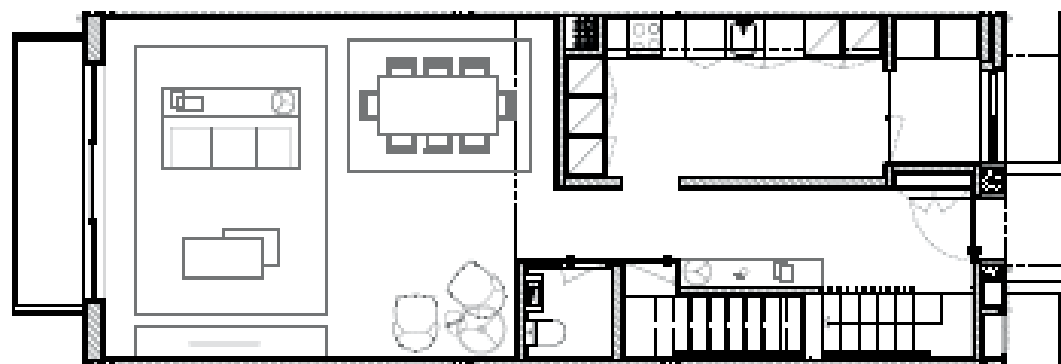

Rés do chão

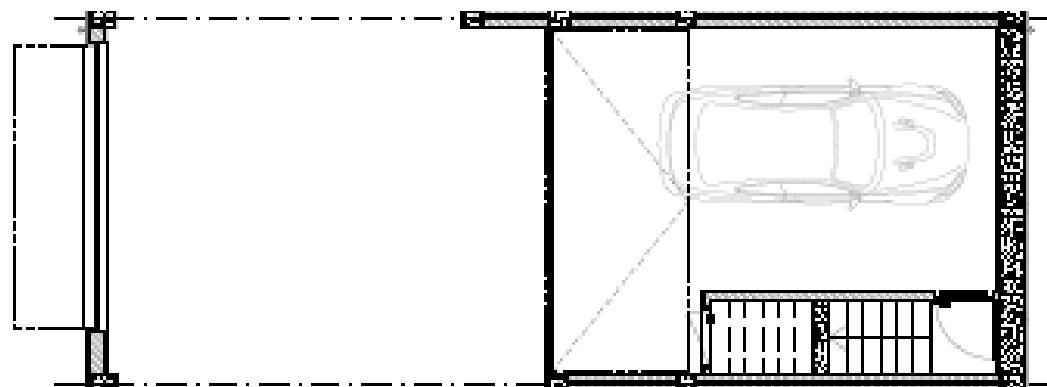

Cave

ALVA

FRAÇÃO AC

ÁREA ÚTIL

159,35 m²

ÁREA BRUTA

191,53 m²

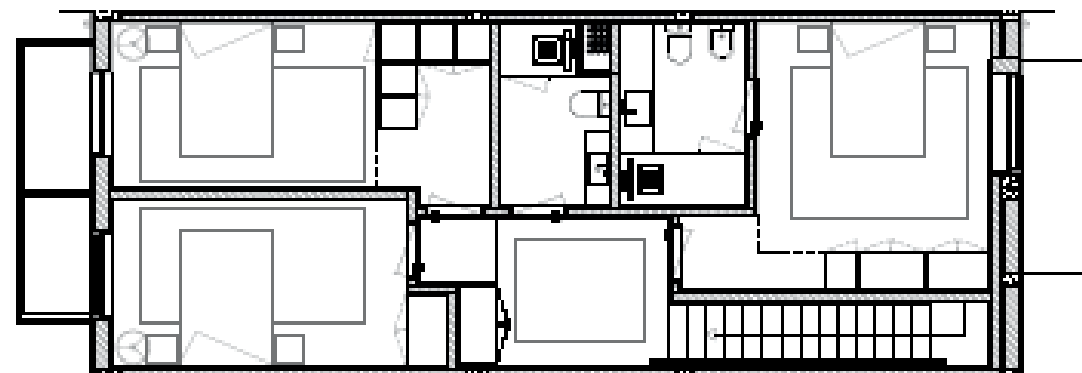

1º Piso

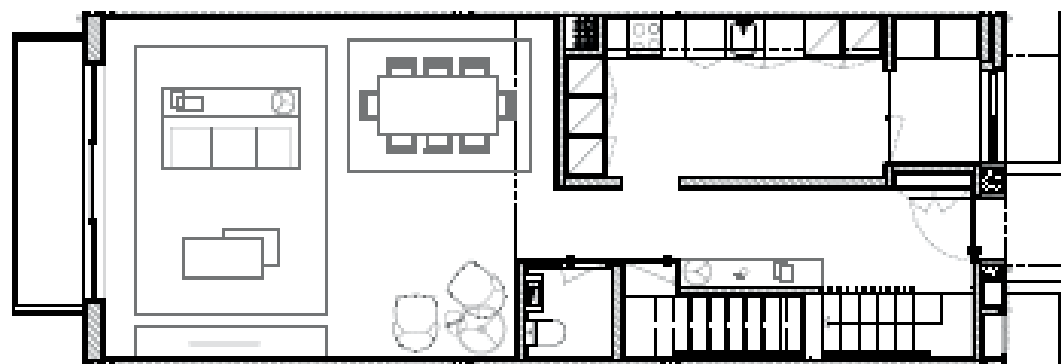

Rés do chão

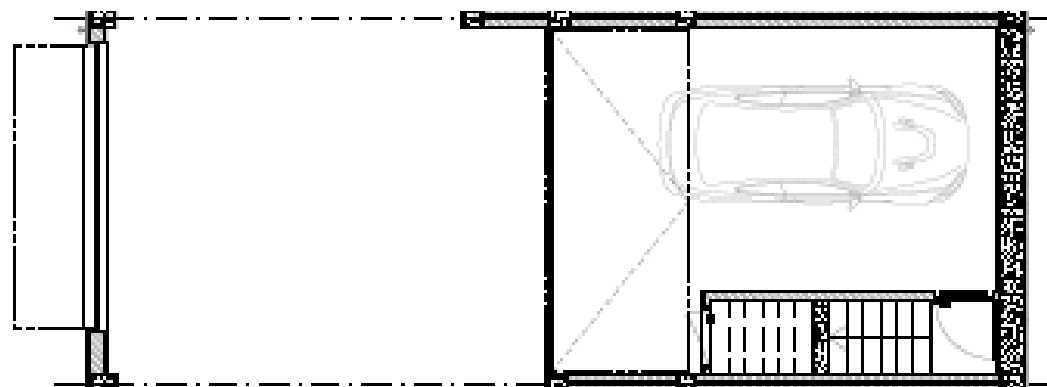

Cave

ALVA

FRAÇÃO AD

ÁREA ÚTIL

179,13 m²

ÁREA BRUTA

219,34 m²

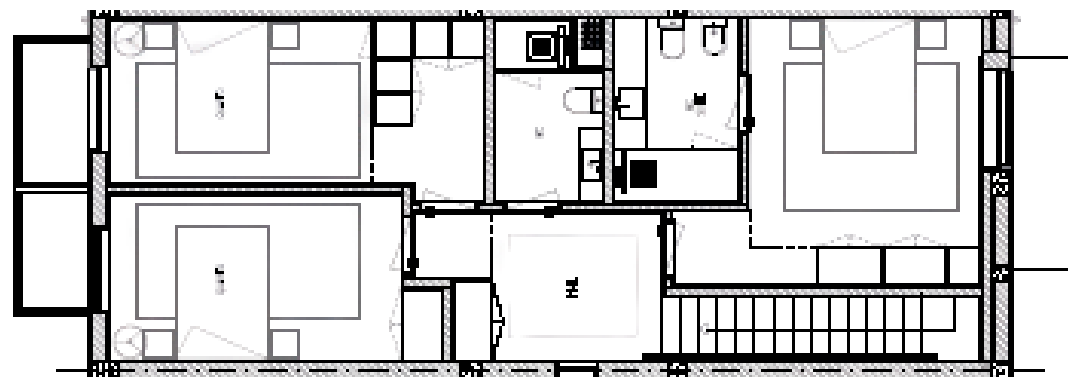

1º Piso

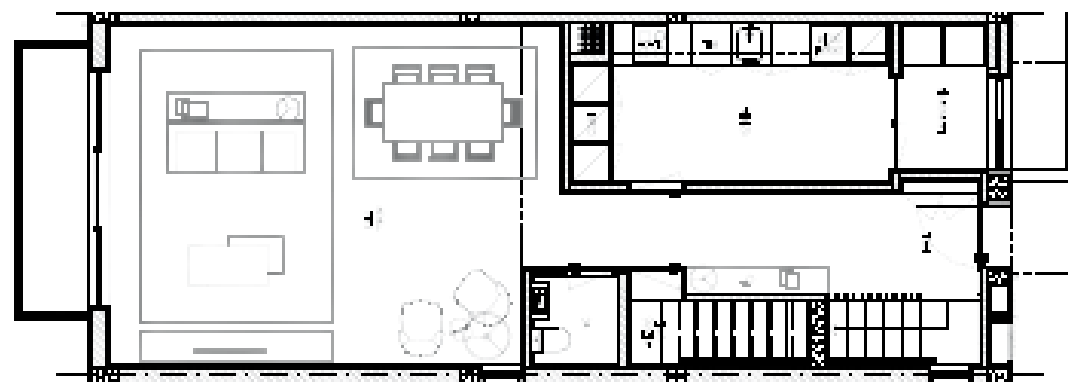

Rés do chão

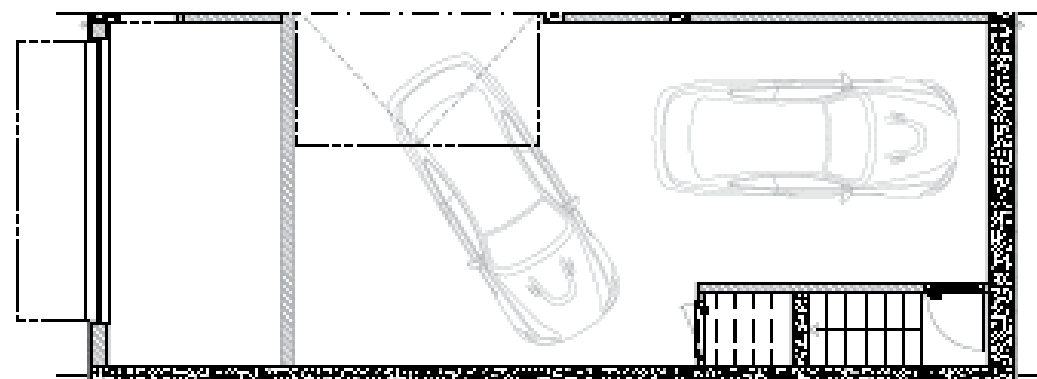

Cave

ALVA

FRAÇÃO AE

ÁREA ÚTIL

193,73 m²

ÁREA BRUTA

236,28 m²

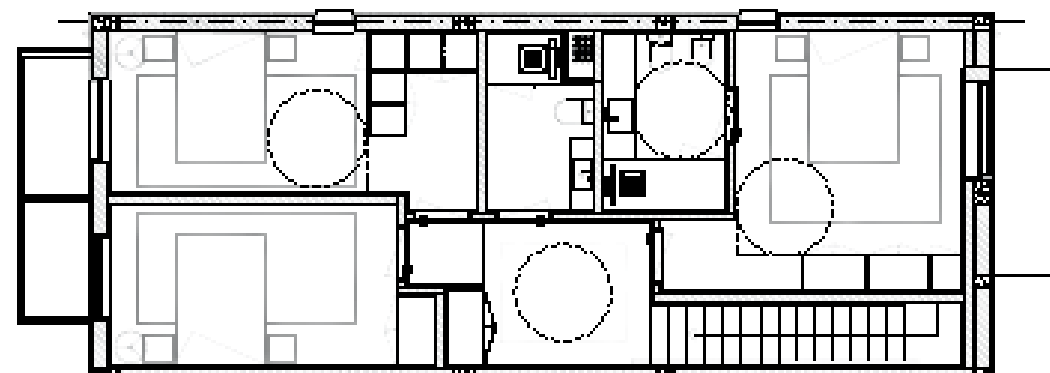

1º Piso

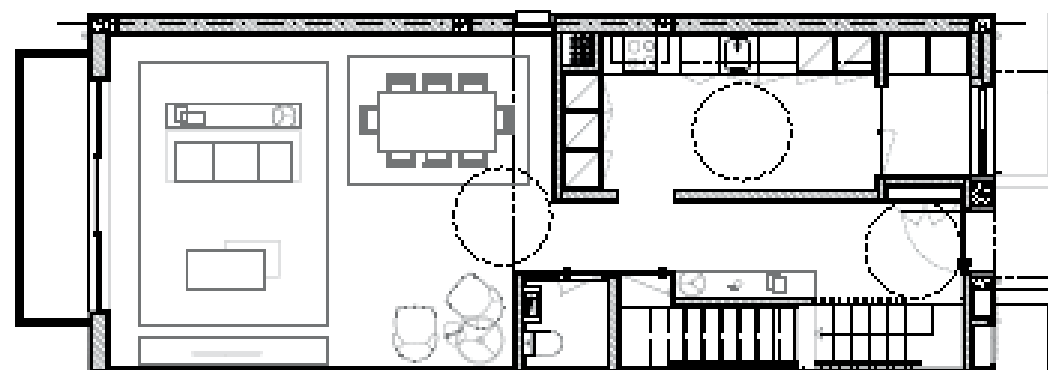

Rés do chão

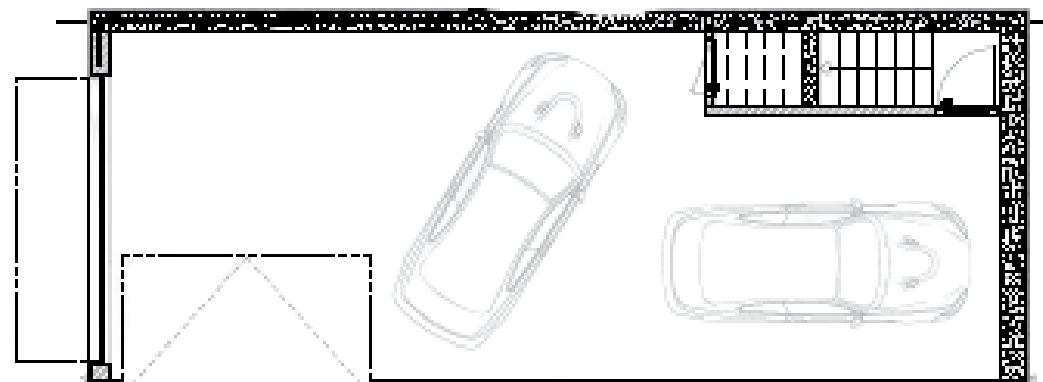

Cave

ALVA

FRAÇÃO AF

ÁREA ÚTIL

165,98 m²

ÁREA BRUTA

198,34 m²

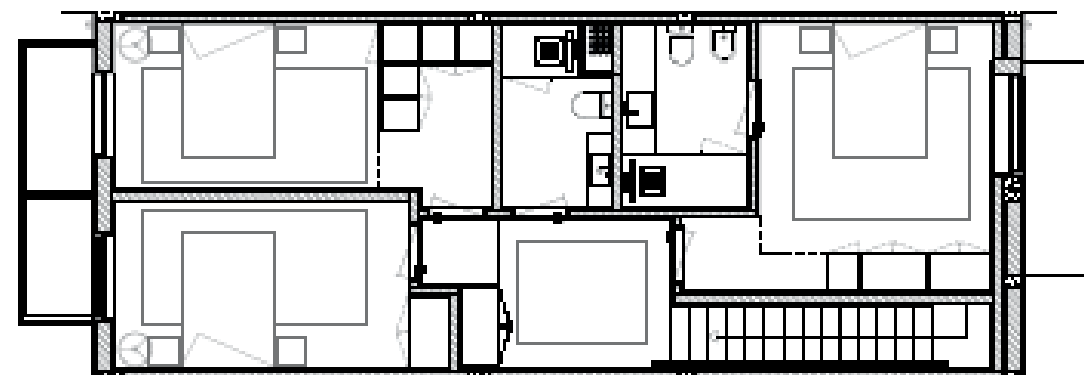

1º Piso

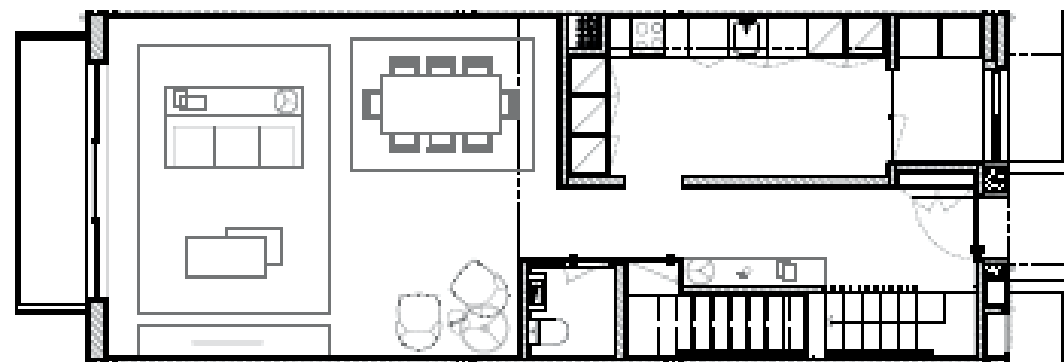

Rés do chão

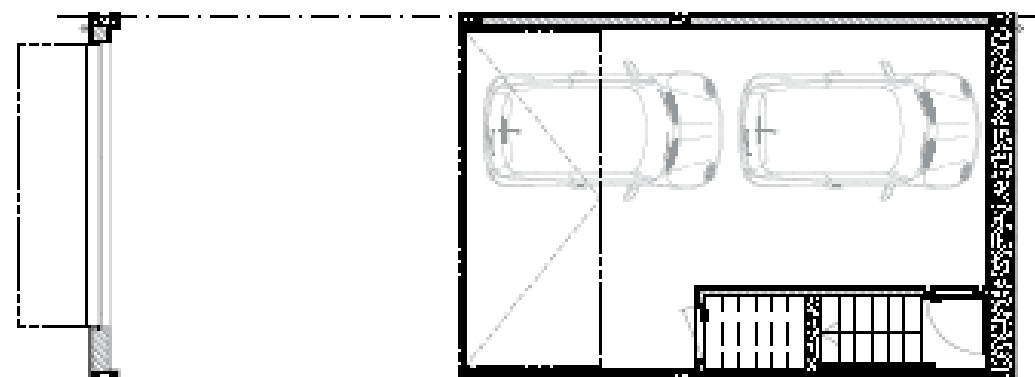

Cave

ALVA

FRAÇÃO AG

ÁREA ÚTIL

165,98 m²

ÁREA BRUTA

198,34 m²

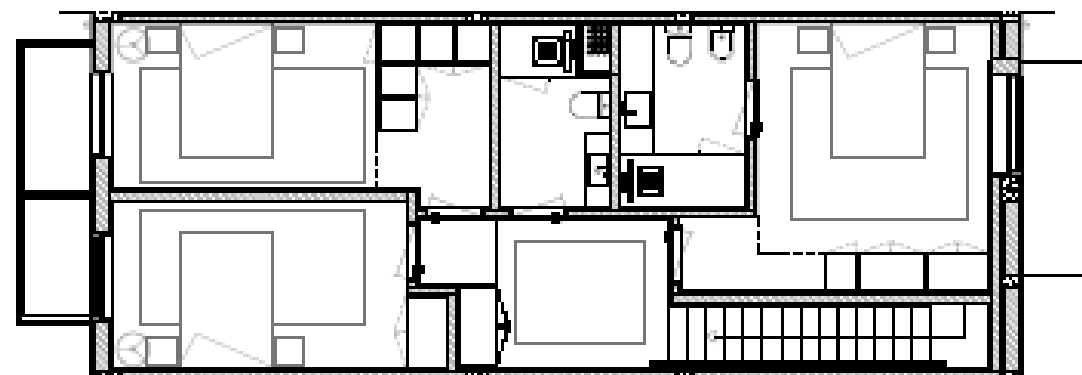

1º Piso

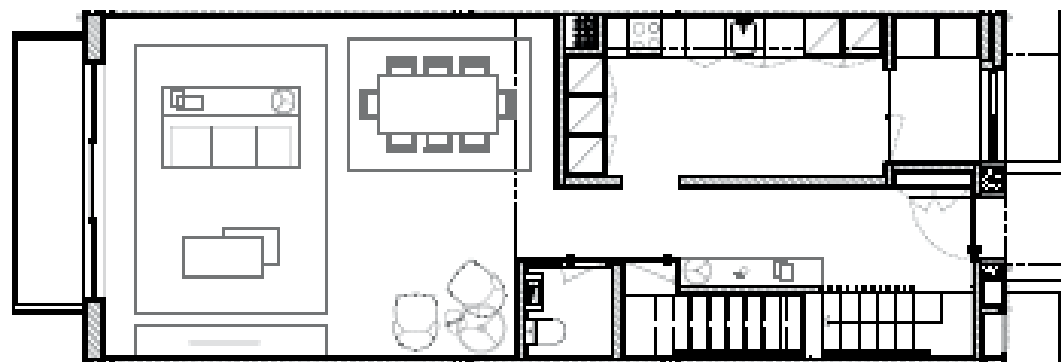

Rés do chão

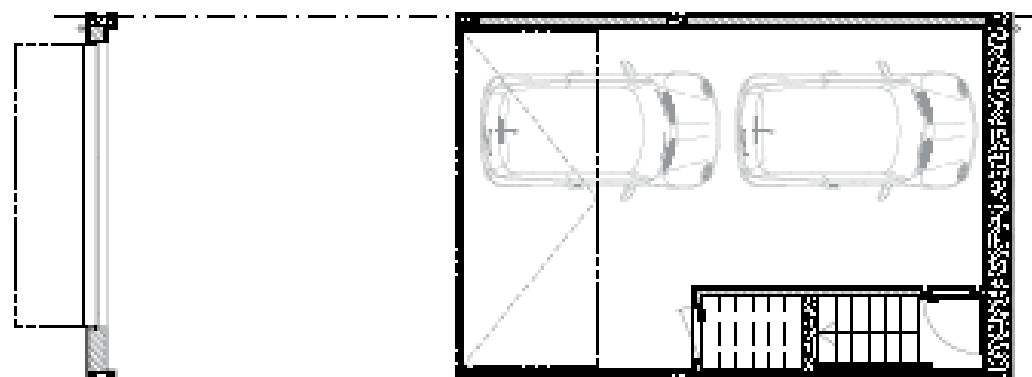

Cave

ALVA

FRAÇÃO AH

ÁREA ÚTIL

165,98 m²

ÁREA BRUTA

198,34 m²

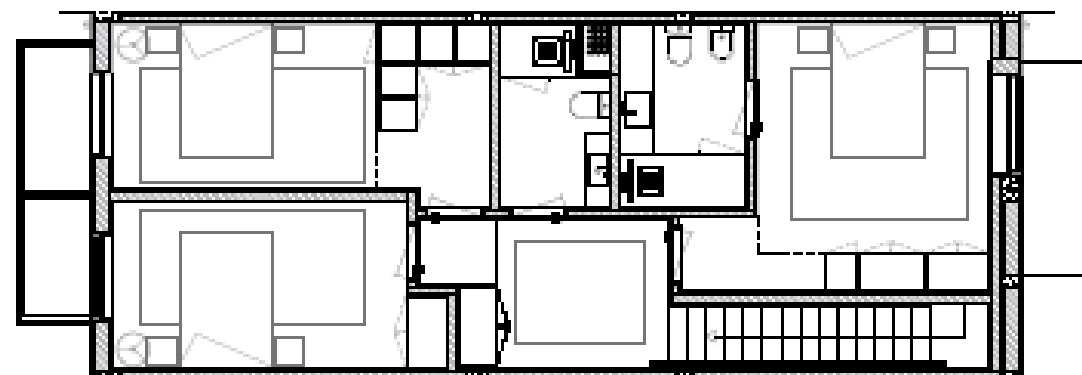

1º Piso

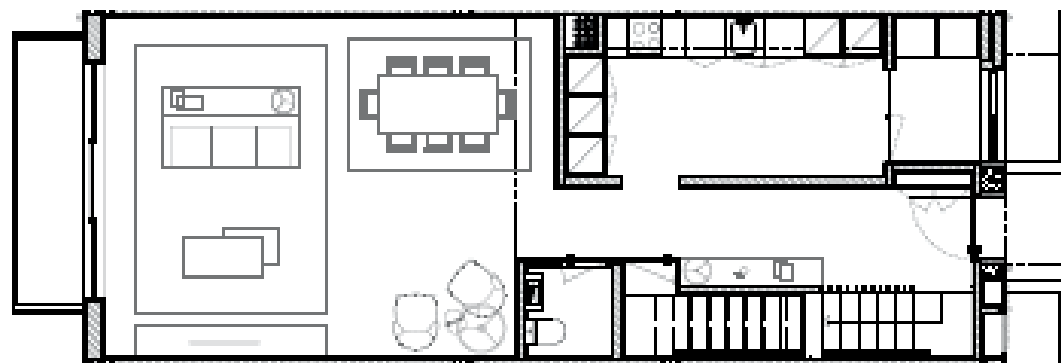

Rés do chão

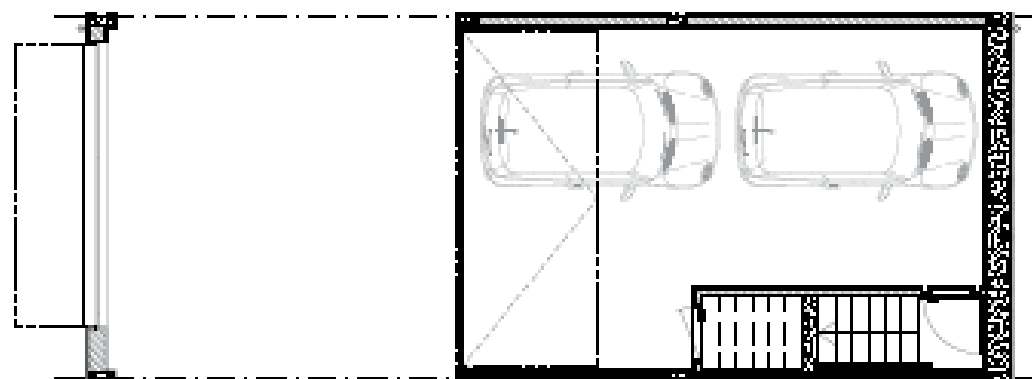

Cave

ALVA

FRAÇÃO AI

ÁREA ÚTIL

165,98 m²

ÁREA BRUTA

203,35 m²

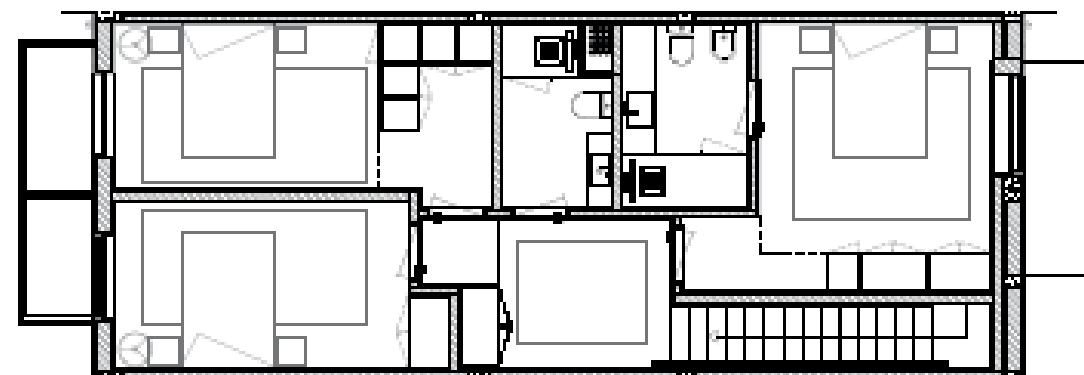

1º Piso

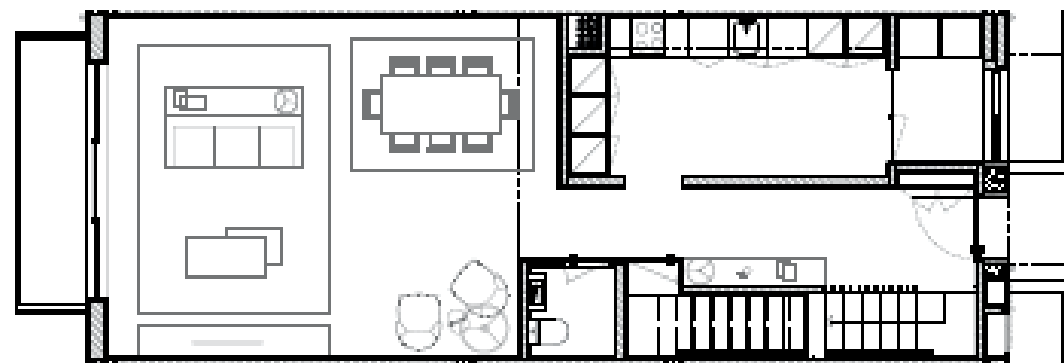

Rés do chão

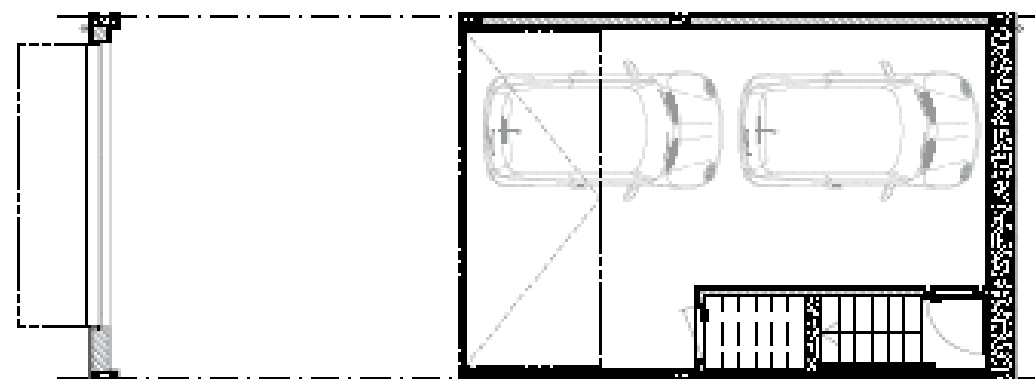

Cave

ALVA

FRAÇÃO AJ

ÁREA ÚTIL

165,98 m²

ÁREA BRUTA

203,35 m²

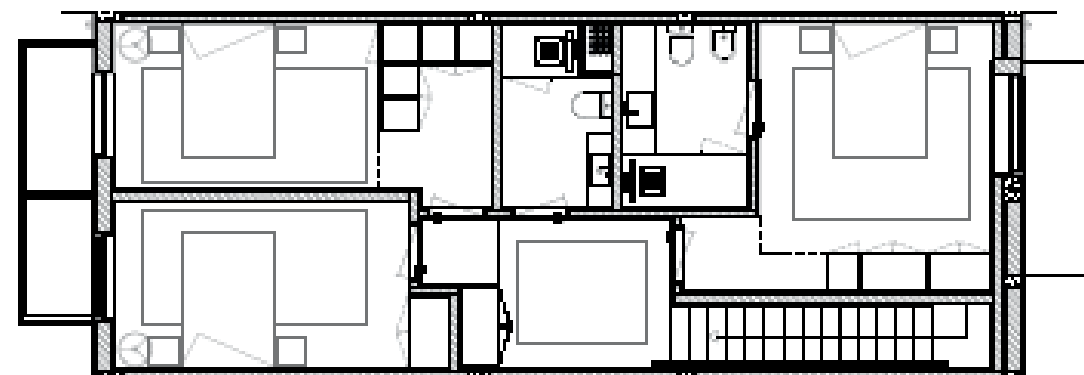

1º Piso

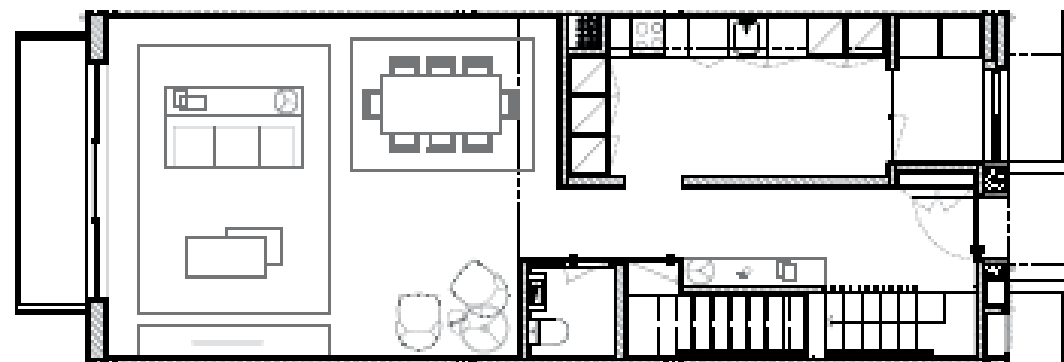

Rés do chão

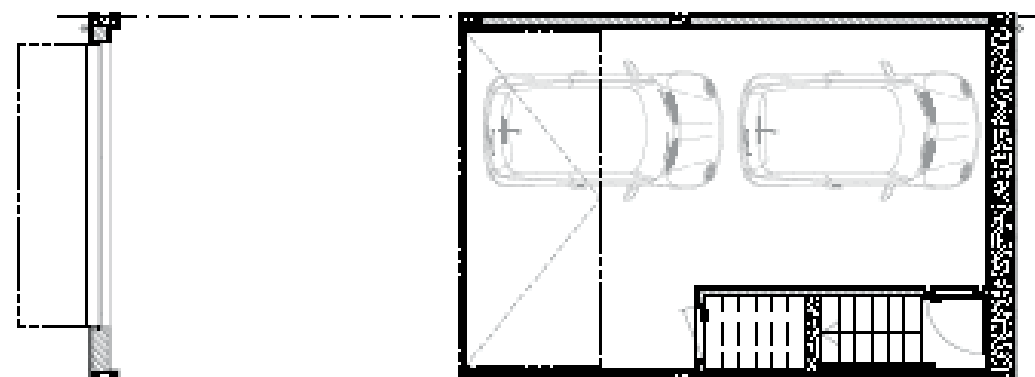

Cave

ALVA

FRAÇÃO AK

ÁREA ÚTIL

165,98 m²

ÁREA BRUTA

198,34 m²

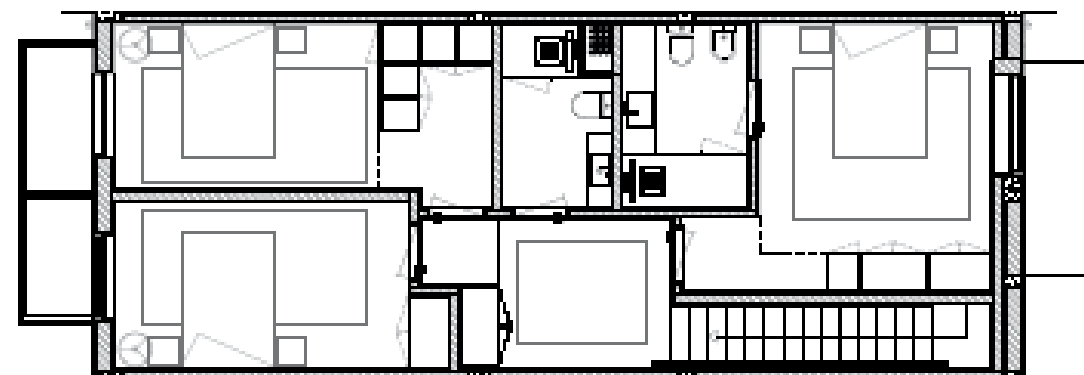

1º Piso

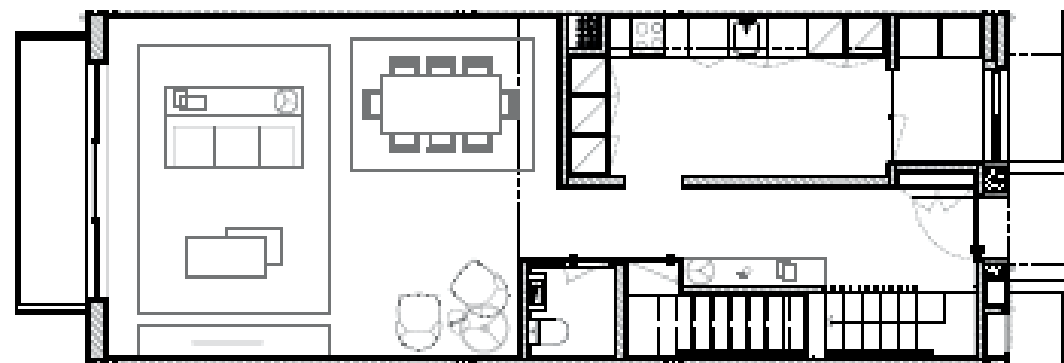

Rés do chão

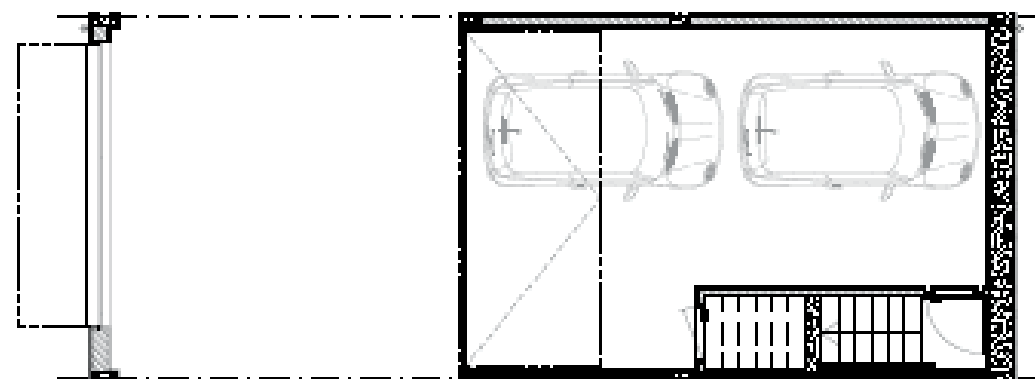

Cave

ALVA

FRAÇÃO AK

ÁREA ÚTIL

165,98 m²

ÁREA BRUTA

198,34 m²

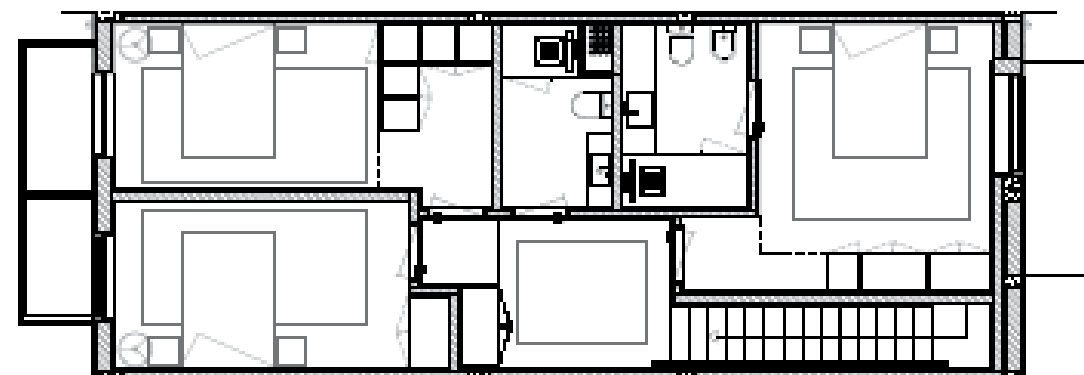

1º Piso

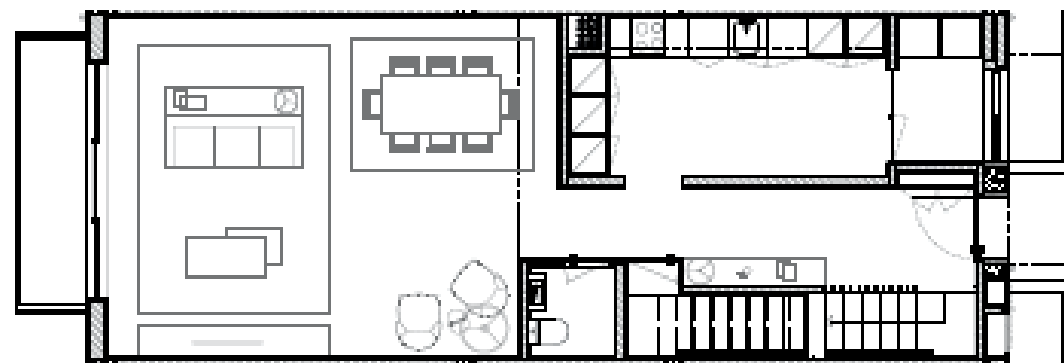

Rés do chão

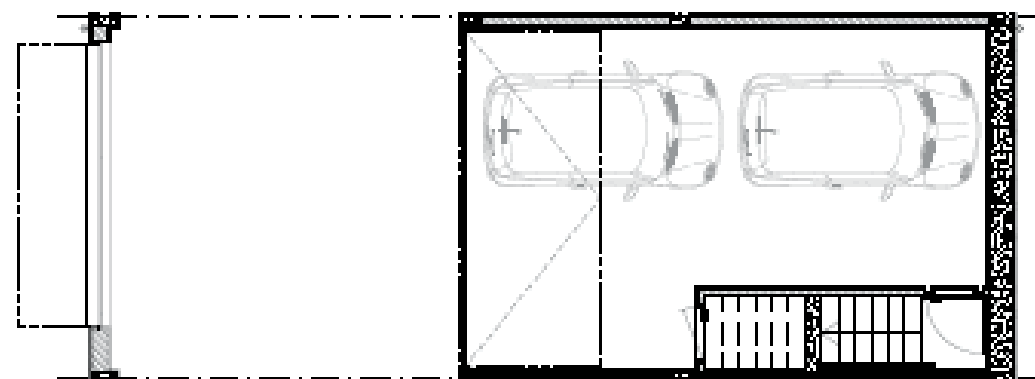

Cave

ALVA

FRAÇÃO AM

ÁREA ÚTIL

165,98 m²

ÁREA BRUTA

198,34 m²

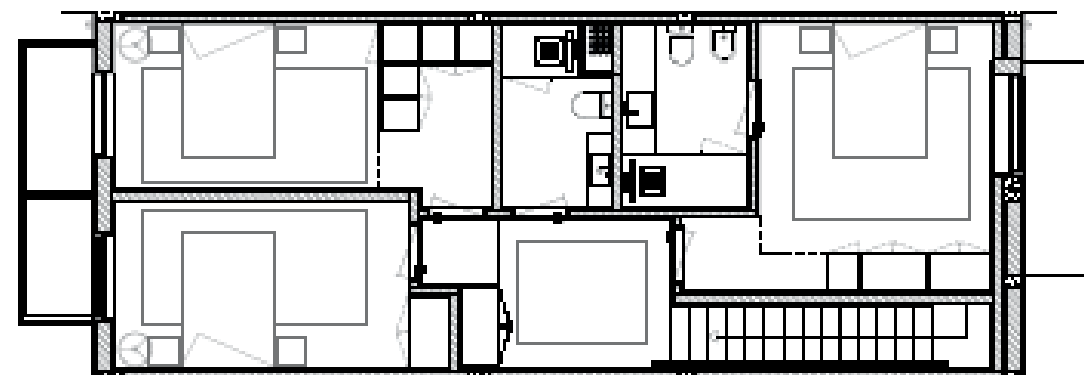

1º Piso

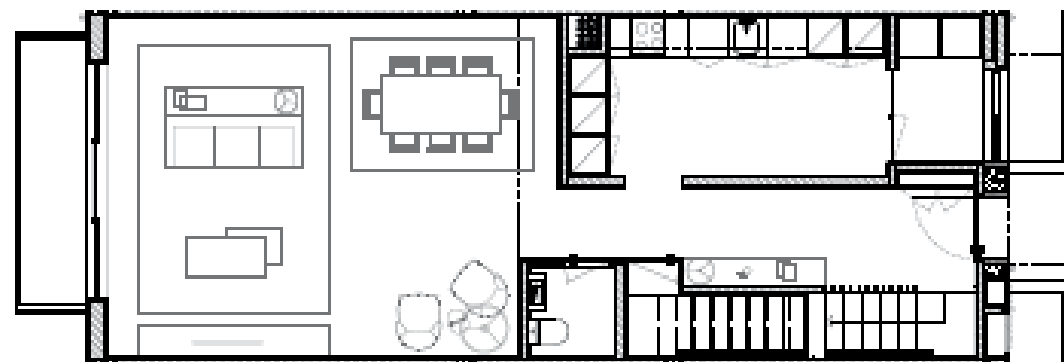

Rés do chão

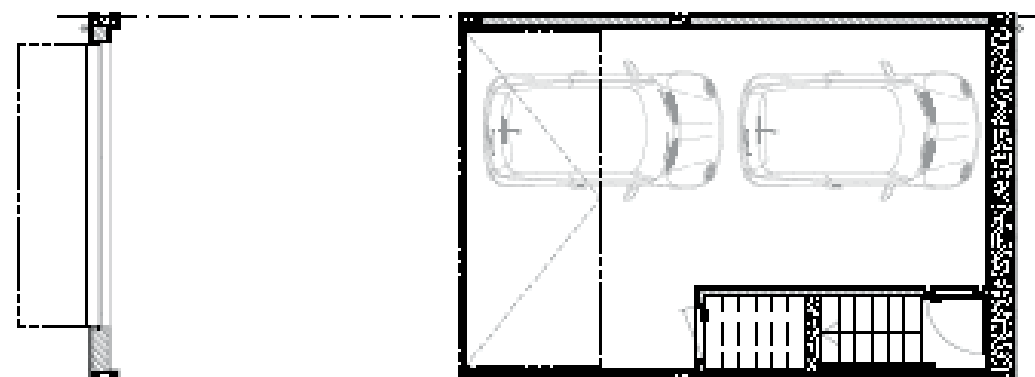

Cave